

Notice

Hewlett-Packard to Agilent Technologies Transition

This documentation supports a product that previously shipped under the Hewlett-Packard company brand name. The brand name has now been changed to Agilent Technologies. The two products are functionally identical, only our name has changed. The document still includes references to Hewlett-Packard products, some of which have been transitioned to Agilent Technologies.



Agilent Technologies

By internet, phone, or fax, get assistance with all your test and measurement needs.

Table 1-1 Contacting Agilent

Online assistance: www.agilent.com/find/assist

United States
(tel) 1 800 452 4844

Latin America
(tel) (305) 269 7500
(fax) (305) 269 7599

Canada
(tel) 1 877 894 4414
(fax) (905) 282-6495

Europe
(tel) (+31) 20 547 2323
(fax) (+31) 20 547 2390

New Zealand
(tel) 0 800 738 378
(fax) (+64) 4 495 8950

Japan
(tel) (+81) 426 56 7832
(fax) (+81) 426 56 7840

Australia
(tel) 1 800 629 485
(fax) (+61) 3 9210 5947

Asia Call Center Numbers

Country	Phone Number	Fax Number
Singapore	1-800-375-8100	(65) 836-0252
Malaysia	1-800-828-848	1-800-801664
Philippines	(632) 8426802 1-800-16510170 (PLDT Subscriber Only)	(632) 8426809 1-800-16510288 (PLDT Subscriber Only)
Thailand	(088) 226-008 (outside Bangkok) (662) 661-3999 (within Bangkok)	(66) 1-661-3714
Hong Kong	800-930-871	(852) 2506 9233
Taiwan	0800-047-866	(886) 2 25456723
People's Republic of China	800-810-0189 (preferred) 10800-650-0021	10800-650-0121
India	1-600-11-2929	000-800-650-1101

HP 83711A/12A and
HP 83711B/12B
Synthesized CW
Generators

HP part number: 83711-90131

Printed in USA July 1997 Supersedes April 1995

Notice.

The information contained in this document is subject to change without notice.

Hewlett-Packard makes no warranty of any kind with regard to this material, including but not limited to, the implied warranties of merchantability and fitness for a particular purpose. Hewlett-Packard shall not be liable for errors contained herein or for incidental or consequential damages in connection with the furnishing, performance, or use of this material.

© Copyright Hewlett-Packard Company 1995, 1997

All Rights Reserved. Reproduction, adaptation, or translation without prior written permission is prohibited, except as allowed under the copyright laws.
1400 Fountaingrove Parkway, Santa Rosa, CA 95403-1799, USA

The HP 83711A/12A and HP 83711B/12B Synthesized CW Generators

The HP 83711A/12A and HP 83711B/12B synthesized CW generators are referred to as “synthesizers” throughout this manual. The HP 83711A/11B has a carrier frequency range of 1 GHz to 20 GHz and the HP 83712A/12B has a carrier frequency range of 10 MHz to 20 GHz. Specification information can be found in Chapter 4, “Specifications and Options.”

The *HP 83711A/12A and HP 83711B/12B Synthesized CW Generators User’s Guide* is written to accommodate the novice and the expert user. If you are unfamiliar with the synthesizer, Chapter 2, “Performing Fundamental Synthesizer Operations,” is useful. If you are familiar with the synthesizer, Chapter 3, “Generating Signals with the Synthesizer” section is helpful. If you are looking for specific, detailed information about the synthesizer, refer to the remaining chapters as needed.

Notes

1. This manual applies to instruments with firmware revision 10.0 or greater.
2. If you have an HP 83711A/12A instrument with firmware revision number < 10.0, refer to the *HP 83711A/12A Synthesized Signal Generator User’s Guide* (5960-7088).
3. To view firmware revision, press **(SPCL)**, **(1)**, **(HZ)** (ENTER).

The Synthesizer at a Glance

The following figure and accompanying text explains some features of the HP 83711A and HP 83711B. The HP 83712A and HP 83712B are nearly identical.

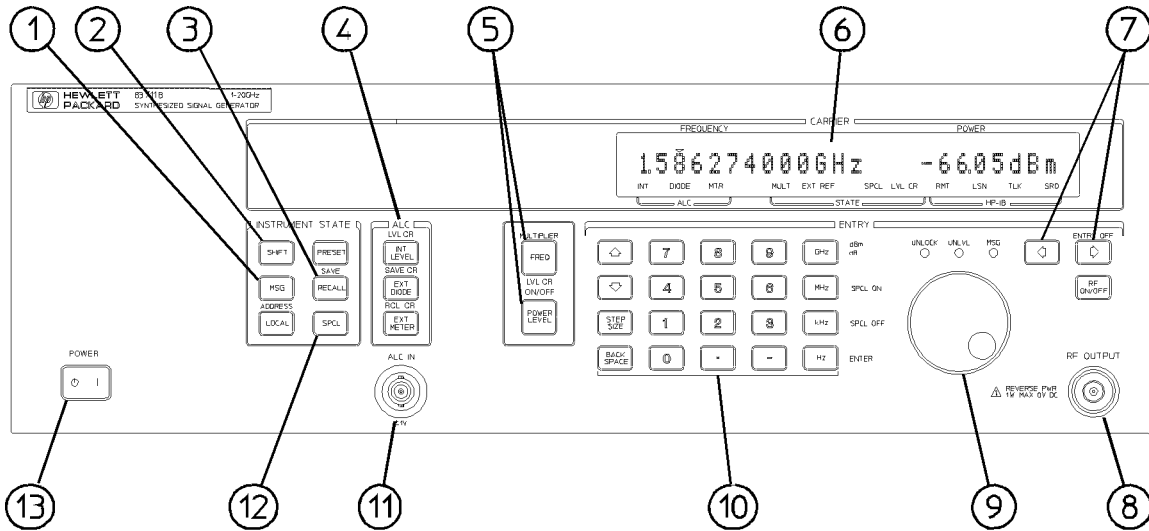

pq61ab_c

HP 83711B Synthesized CW Generator

1. The **(MSG)** key allows you to display any error messages on the front panel display. Error messages are generated when you perform a keystroke sequence that is not valid, try to operate the synthesizer in a mode that is not allowed, etc.
2. The **(SHIFT)** key changes the function of some of the keys. When you press the **(SHIFT)** key and then press another key, the synthesizer performs the function printed in blue above the key.
3. The **(RECALL)** / SAVE key is used to save most of the synthesizer operating parameters in one of nine nonvolatile register locations so that they can be recalled and used at a later time.
4. The Automatic Level Control keys select the method used to regulate the synthesizer output power level. Either internal leveling, external power meter leveling, or external diode detector leveling can be selected. Additional external equipment is required when either external power meter leveling or external diode detector leveling is used.
5. These keys set the carrier frequency and RF output power level of the synthesizer.
6. The display shows the current values of synthesizer parameters as well as the status of many of the synthesizer functions. The display shows the current carrier frequency and output power level. The annunciators that appear below the parameters are only visible when their associated function is active.
7. The **(←)** and **(→)** keys move the cursor that is over one of the digits in the display either to the right or left when pressed. The digit that is under the cursor will be modified when the knob is rotated. If no cursor appears in the display, parameter entry or modification has been inhibited.
8. The **RF OUTPUT** connector mates with a Type-N male connector on non-Option 1E9 instruments. The connector mates with a female APC-3.5 mm precision connector on instruments with Option 1E9 installed.
9. The knob is used to increase or decrease the digit under the cursor | ▼ | in the display in steps of one.
10. The data entry keys are used to enter and modify various synthesizer parameters. The **(BACKSPACE)** key cancels all or part of an erroneous parameter entry before it has been terminated. The terminator keys (the right-most column of keys) are used to choose the units for the entered parameter as well as to terminate the parameter entry. The **(↑)**, **(↓)**, and **(STEP SIZE)** keys are used to increase or decrease a parameter in predetermined steps.
11. The Automatic Level Control voltage input (ALC IN) connector is used as the feedback path to the synthesizer when its RF output power level is being leveled externally.
12. The **(SPCL)** key is used to initiate the activation of several special functions available in the synthesizer. Special functions are additional functions that are not activated by pressing a front panel key or shifted key.
13. The POWER switch (LINE on an HP 83711A/12A) turns the synthesizer either on or off.

Synthesizer rear panel features are depicted and described in detail in Chapter 5, “Front/Rear Panel,” in this book.

In This Book

This book is divided into the following chapters:

- **Chapter 1**, “Installing and Verifying the Synthesizer,” contains procedures for installing the synthesizer and verifying its operation.
- **Chapter 2**, “Performing Fundamental Synthesizer Operations,” familiarizes you with the fundamental operation of the synthesizer.
- **Chapter 3**, “Generating Signals with the Synthesizer,” explains how to generate CW signals and level signals.
- **Chapter 4**, “Specifications and Options,” contains a list of the synthesizer performance specifications as well as the various mechanical, electrical, warranty, and documentation options that are available.
- **Chapter 5**, “Front/Rear Panel,” contains entries that explain different aspects of the synthesizer front and rear panel. (For example, you turn to this chapter for information on the RF connectors).
- **Chapter 6**, “Keys/Shifted Functions,” contains entries on the function of each key on the synthesizer front panel as well as the shifted or alternate function of certain keys.
- **Chapter 7**, “Special Functions,” contains entries on the special functions available in the synthesizer. Special functions are hidden during normal instrument operation and can only be invoked by typing a specific key sequence on the synthesizer front panel.
- **Chapter 8**, “Error Messages,” contains a table that lists all of the error messages that might be generated during use of the instrument. Each table entry contains a sequence that can be followed to recover from the error condition.
- **Chapter 9**, “Legal and Regulatory Information,” contains information related to safety and SCPI conformance information. The product warranty is also contained in this chapter.

Contents

1. Installing and Verifying the Synthesizer	
Installing the Synthesizer	1-3
To Unpack the Synthesizer	1-3
To Install the Synthesizer	1-5
Verifying Synthesizer Functionality	1-7
If You Encounter a Problem	1-8
Mechanical or Electrical Damage	1-8
Power-up Problems	1-9
Self Test Failures	1-11
2. Performing Fundamental Synthesizer Operations	
To Enter Data with the Numeric Keypad	2-3
To Modify Data with the Knob	2-4
To Modify Data with the Arrow Keys	2-6
To Save and Recall Synthesizer States	2-8
Programming Example	2-9
To Read the Contents of the Error Queue	2-10
Programming Example	2-11
To Set the HP-IB Address	2-12
Programming Example	2-12
If You Encounter a Problem	2-13
Data Entry Problems	2-13
Programming Problems	2-15
3. Generating Signals with the Synthesizer	
To Generate a CW Signal	3-3
To Generate Millimeter Signals	3-4
To Use External Diode Detector Leveling	3-7
Programming Command	3-10
Related Tasks	3-10
To Use External Power Meter Leveling	3-11
Programming Commands	3-13
Related Tasks	3-13
To Use the Level Correct Routine	3-14
Related Tasks	3-19
To Use Previously Stored Level Correct Data	3-20

Related Tasks	3-21
If You Encounter a Problem	3-22
Annunciators Turned On	3-22
RF Output Problems	3-23

4. Specifications and Options

HP 83711A/11B Specifications	4-3
Frequency	4-3
RF Output	4-4
Spectral Purity	4-6
HP 83712A/12B Specifications	4-9
Frequency	4-9
RF Output	4-10
Spectral Purity	4-13
General	4-17
Front Panel Connectors	4-18
Rear Panel Connectors	4-19
Options	4-20
Electrical Options	4-20
Option 1E1 - Add Output Step Attenuator	4-20
Option 1E5 - Add High Stability Timebase	4-20
Option 1E8 - 1 Hz Frequency Resolution	4-20
Option 1E9 - 3.5 mm RF Output Connector	4-21
Mechanical Options	4-21
Option 1CM - Rack Mount Kit	4-21
Option 1CP - Rack Mount and Handle Kit	4-21
Option 1CR - Rack Slide Kit	4-21
Warranty Options	4-22
Option W30 - Two Additional Years Return-to-HP Service	4-22
Option W32 - Three Year Return-to-HP Calibration Service	4-22
Documentation Options	4-22
Option OB0 - Delete Operating Documentation	4-22
Option OB1 - Extra Operating Documentation	4-23
Option OBV - Component-Level Information Packet (CLIP)	4-23
Option OBW - Service Documentation	4-23
Option OBX - Component-Level Information Packet (CLIP)/Service Documentation	4-23

5. Front/Rear Panel

Annunciators	5-3
See Also	5-5
Connectors	5-6
Coaxial Connectors	5-7
HP-IB Connector	5-8
Display	5-11
See Also	5-12
Knob	5-13
Equivalent SCPI Command	5-13
See Also	5-14
POWER Switch	5-15
See Also	5-15
Power Cables	5-16

6. Keys/Shifted Functions

⇒	6-3
Equivalent SCPI Command	6-4
See Also	6-4
⇐	6-5
Equivalent SCPI Command	6-6
See Also	6-6
↑	6-7
Equivalent SCPI Commands	6-7
See Also	6-8
↓	6-9
Equivalent SCPI Commands	6-9
See Also	6-10
ADDRESS	6-11
Equivalent SCPI Command	6-11
See Also	6-11
BACK SPACE	6-12
Equivalent SCPI Command	6-12
See Also	6-12
ENTER (Hz)	6-13
Equivalent SCPI Command	6-13
See Also	6-14
ENTRY OFF	6-15
Equivalent SCPI Command	6-15
See Also	6-15
EXT DIODE	6-16

External Diode Detector Leveling	6-16
Applications	6-17
Advantages of Diode Detector Leveling	6-18
Disadvantages of Diode Detector Leveling	6-18
Equivalent SCPI Command	6-19
See Also	6-19
EXT METER	6-20
External Power Meter Leveling	6-20
Applications	6-22
External Equipment Limitations	6-22
Power Meter	6-22
Power Sensor	6-22
Advantages of Power Meter Leveling	6-23
Disadvantages of Power Meter Leveling	6-23
Equivalent SCPI Commands	6-24
See Also	6-24
FREQ	6-25
Equivalent SCPI Command	6-26
See Also	6-26
INT LEVEL	6-27
Advantages of Internal Leveling	6-28
Disadvantages of Internal Leveling	6-28
Equivalent SCPI Commands	6-29
See Also	6-29
LOCAL	6-30
Equivalent SCPI Command	6-30
See Also	6-30
LVL CR	6-31
Equivalent SCPI Command	6-34
See Also	6-34
LVL CR ON/OFF	6-35
Equivalent SCPI Commands	6-36
See Also	6-36
MSG	6-37
Equivalent SCPI Command	6-37
See Also	6-37
MULTIPLIER	6-38
Equivalent SCPI Command	6-39
See Also	6-39
Numeric Keypad	6-40
See Also	6-40

POWER LEVEL	6-41
Equivalent SCPI Command	6-42
See Also	6-42
PRESET	6-43
Equivalent SCPI Commands	6-44
See Also	6-44
RCL CR	6-45
Equivalent SCPI Command	6-46
See Also	6-46
RECALL	6-47
Equivalent SCPI Command	6-47
See Also	6-47
RF ON/OFF	6-48
Equivalent SCPI Command	6-48
See Also	6-48
SAVE	6-49
Equivalent SCPI Command	6-49
See Also	6-49
SAVE CR	6-50
Equivalent SCPI Command	6-51
See Also	6-51
SHIFT	6-52
Equivalent SCPI Command	6-52
See Also	6-52
SPCL	6-53
Equivalent SCPI Command	6-53
SPCL OFF (kHz)	6-54
Equivalent SCPI Command	6-54
See Also	6-55
SPCL ON (MHz)	6-56
Equivalent SCPI Command	6-56
See Also	6-56
STEP SIZE	6-57
Equivalent SCPI Commands	6-57
See Also	6-58

7. Special Functions

ATTEN HOLD ON/OFF	7-3
Applications	7-4
Advantages	7-4
Disadvantages	7-5
Equivalent SCPI Command	7-5
See Also	7-5
CLEAR DISPLAY	7-6
Equivalent SCPI Command	7-7
See Also	7-7
ERASE MEMORY	7-8
Application	7-8
Equivalent SCPI Command	7-8
See Also	7-9
PWR MTR ADDRS	7-10
Equivalent SCPI Command	7-11
See Also	7-11
PWR MTR SELECT	7-12
Equivalent SCPI Command	7-12
See Also	7-13
REMOTE LANGUAGE	7-14
Equivalent SCPI Command	7-14
See Also	7-14
SELF TEST	7-15
Equivalent SCPI Command	7-16
See Also	7-16
Service-Related Special Functions	7-17
See Also	7-17
SHOW INFO	7-18
Equivalent SCPI Command	7-18
See Also	7-18

8. Error Messages

Error Messages List	8-3
Messages	8-5

9. Legal and Regulatory Information	
Safety Symbols	9-3
Miscellaneous Symbols	9-4
Safety Considerations	9-5
Before Applying Power	9-5
Safety Earth Ground	9-5
Cleaning the Product	9-6
Certification	9-7
Warranty	9-8
Limitation of Warranty	9-8
Exclusive Remedies	9-9
Assistance	9-10

Index

Figures

1-1. Line Fuse Removal and Replacement	1-10
3-1. Millimeter-Wave Equipment Setup	3-4
3-2. External Diode Detector Leveling Setup	3-8
3-3. External Power Meter Leveling Setup	3-11
3-4. Level Correct Routine Equipment Setup	3-15
4-1. Typical Maximum Available Output Power from 1 to 20 GHz, at 25 °C with Output Step Attenuator (Option 1E1) Installed	4-4
4-2. Typical Output Level Accuracy and Flatness at +10 and –85 dBm	4-5
4-3. Typical single-sideband phase noise at 1 GHz, 10 GHz and 20 GHz, 25 °C, CW mode. Offsets less than 100 Hz require the high stability timebase, Option 1E5.	4-6
4-4. Typical 2nd Harmonic Levels Measured at Output Power of +6 dBm	4-7
4-5. Typical Residual FM Measured in 50 Hz - 15 kHz Bandwidth, CW Mode, with High Stability Timebase (Option 1E5)	4-8
4-6. Typical Maximum Available Output Power from 1 to 20 GHz, at 25 °C with Output Step Attenuator (Option 1E1) Installed	4-10
4-7. Typical Maximum Available Output Power from 0.01 to 1 GHz at 25 °C.	4-11
4-8. Typical Output Level Accuracy and Flatness at +10 and –85 dBm	4-12
4-9. Typical single-sideband phase noise at 50 MHz, 1 GHz, 10 GHz and 20 GHz, 25 °C, CW mode. Offsets less than 100 Hz require the high stability timebase, Option 1E5.	4-14
4-10. Typical 2nd Harmonic Levels Measured at Output Power of +6 dBm	4-15
4-11. Typical Residual FM Measured in 50 Hz - 15 kHz Bandwidth, CW mode, with High Stability Timebase (Option 1E5)	4-16
5-1. Synthesizer Display Annunciators	5-3
5-2. Synthesizer Connectors - Front Panel	5-6
5-3. Synthesizer Connectors - Rear Panel	5-6
5-4. HP-IB Connector and Cable	5-8
5-5. Synthesizer Display	5-11
5-6. Power Cable and Line (Mains) Plug Part Numbers	5-17

6-1. External Diode Detector Leveling Setup	6-17
6-2. External Power Meter Leveling Setup	6-21

Tables

4-1. Offsets (HP 83711A only)	4-6
4-2. Offsets (HP 83711B only)	4-6
4-3. Offsets (HP 83712A only)	4-13
4-4. Offsets (HP 83712B only)	4-13
5-1. HP-IB Interface Cables Available	5-8
6-1. PRESET Conditions	6-43
7-1. Service-Related Special Functions	7-17
9-1. Hewlett-Packard Sales and Service Offices	9-11

Installing and Verifying the Synthesizer

Installing and Verifying the Synthesizer

This chapter contains procedures for properly installing your HP 83711A/12A or HP 83711B/12B synthesizer and procedures for functional verification of the instrument.

Installing the Synthesizer

This procedure explains how to inspect, install, and power-up the synthesizer.

To Unpack the Synthesizer

1. Inspect the shipping container for damage.

Look for signs of damage such as a dented or torn shipping container or cushioning material that shows signs of unusual stress or compacting.

2. Carefully remove the contents from the shipping container and inspect each item for damage.

If the instrument or any accessories appear to be damaged, refer to “Mechanical or Electrical Damage” at the end of this chapter. The following items should have been received in the shipment.

Installing the Synthesizer

Item	Model/Part Number
Instrument	HP 83711A/12A <i>or</i> HP 83711B/12B
Power Cable	Depends on shipment destination. Refer to "Power Cables" in Chapter 5 of this manual.
User's Guide	83711-90131
Quick Start Guide	83711-90133
Programming Guide	83711-90132
Calibration Guide	83731-90125
Calibration Kit	5063-1635
Calibration Guide	83731-90125
Calibration Software	5010-7723
<i>Also includes one of the following:</i>	
Handle Kit	5062-3989 standard
Rack Mount Kit	5062-3977 Option 1CM
Rack Mount Kit with Handles	5062-3983 Option 1CP
Rack Slide Kit	1494-0059 Option 1CR

3. Keep the shipping materials for future use.

If undamaged, shipping materials are useful for shipment or storage of the instrument. If damaged, shipping materials should be kept for the carrier's inspection.

To Install the Synthesizer

The following provides a general procedure for installation and initial power up of the HP 83711A/12A or HP 83711B/12B synthesizer.

1. Check to make sure that the power cable is undamaged.

Do not use the power cable if the plug contacts are bent or broken or if the wire insulation is damaged or if wire is exposed. Never use a power cable if the grounding contact has been removed.

CAUTION

Always use the three-prong AC power cord supplied with this product. Failure to ensure adequate earth grounding by not using this cord may cause product damage.

2. Set the POWER switch (LINE on an HP 83711A/12A) on the synthesizer to standby (⏻).
3. Set the line voltage selector switch to match the mains voltage.

The line voltage selector switch is located on the rear panel of the synthesizer to the right of the power module. Use a small flat blade screwdriver to set the switch up for mains voltages in the range of 90 V to 132 V; 50, 60, or 400 Hz or down for mains voltages in the range of 198 V to 264 V; 50 or 60 Hz.

Installing the Synthesizer

WARNING

This is a Safety Class I product (provided with a protective earthing ground incorporated in the power cord). The mains plug shall only be inserted in a socket outlet provided with a protective earth contact. Any interruption of the protective conductor inside or outside of the product is likely to make the product dangerous. Intentional interruption is prohibited.

4. Push the module end of the power cable into the power module on the rear panel of the synthesizer until it is firmly seated.
5. Connect the plug end of the power cable to a suitable mains power receptacle.
6. Set the POWER switch (LINE on an HP 83711A/12A) to on (I).

When you turn the synthesizer on, the displays and annunciators light momentarily and the ventilation fan starts. In addition, it is normal for the LED annunciators (including the MSG LED) to turn on and then off during a power-up test. (The MSG LED should be off when the power-up test is complete.)

NOTE

Error message 940 TIMEBASE OVEN COLD will remain on after the power-up test if the instrument has the Option 1E5 installed, and has been disconnected from the mains power. This error should go away after a short warm-up period.

Once the power-up test is complete, frequency and power level will be displayed in the right-most display and pulse parameters will be shown in the display if pulse modulation is enabled.

Verifying Synthesizer Functionality

The verification procedure is suitable for incoming inspection; however, you can refer to the *HP 83711A/12A and 83711B/12B Synthesized CW Generators Service Guide* or the *HP 83711A/12A, HP 83711B/12B, HP 83731A/32A, and HP 83731B/32B Synthesized CW Generators Calibration Guide* for procedures that test all warranted specifications.

1. Activate the SELF TEST special function.

To activate the SELF TEST special function, perform the following procedure.

- a. Press the **(SPCL)** key.
- b. Press **(5)** on the synthesizer numeric keypad.
- c. Terminate the special function entry by pressing the **(Hz)** (ENTER) key.

The display will read SELF TEST?, PRESS ENTER.

2. Press the ENTER key again to initiate the synthesizer self test routine.

When the self test routine is running, the display will alternately read SELF TESTING and PRESETTING INSTRUMENT. After the test completes, the display momentarily reads SELF TEST PASSED.

3. If the self test indicates an error condition, refer to the section entitled “If You Encounter a Problem” at the end of this chapter.

If an error condition exists, the display will momentarily read TEST XX = YY where XX and YY are numbers indicating the error condition.

If You Encounter a Problem

If you have a problem while installing or verifying the synthesizer, check the following list of commonly encountered problems and troubleshooting procedures.

If the problem that you encounter is not in the following list, contact the nearest Hewlett-Packard office for assistance.

NOTE

When transporting the product, use original packaging or comparable only.

Mechanical or Electrical Damage

If the instrument is mechanically or electrically damaged:

- Contact the nearest Hewlett-Packard office.

If the shipping materials are damaged and the instrument is mechanically or electrically damaged:

- Contact the carrier as well as the nearest Hewlett-Packard office.
- Keep the shipping materials for the carrier's inspection.

Power-up Problems

If the synthesizer has no power:

- Check that the power cord is fully seated in both the mains power receptacle and the synthesizer power module.
- Check that the synthesizer line fuse is not open.

WARNING

For continued protection against fire hazard, replace line fuse only with same type and ratings (type nA/nV). The use of other fuses or materials is prohibited.

Refer to Figure 1-1 to remove the fuse from the power module. You can use a continuity light or an ohmmeter to check the fuse. An ohmmeter should read very close to zero ohms if the fuse is good. The 6.3A, 250 V fuse is HP part number 2110-0703.

If You Encounter a Problem

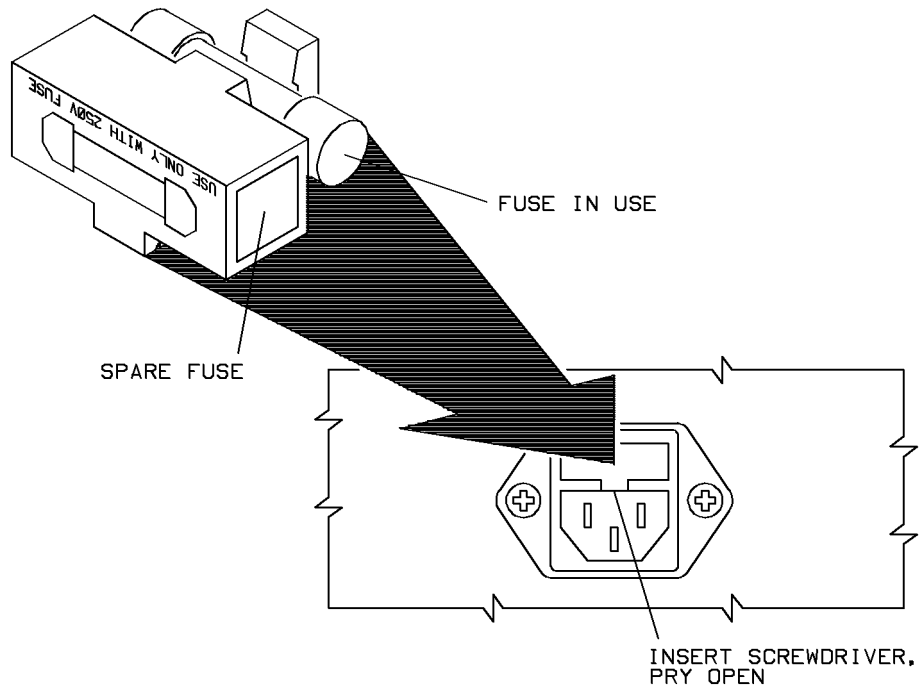

Figure 1-1. Line Fuse Removal and Replacement

- Contact the nearest Hewlett-Packard office for service, if necessary.
- If the display lights, but the ventilation fan does not start:
- Check that the fan is not stuck. To check the fan, follow these steps:
 1. Set the POWER switch (LINE on an HP 83711A/12A) to standby (⏻).
 2. Check that the fan blades are not jammed.
 - Contact the nearest Hewlett-Packard office for service, if necessary.

If the synthesizer MSG LED annunciator remains on after the power-up test is complete:

NOTE

Error message 940 TIMEBASE OVEN COLD will remain on after the power-up test if the instrument has the Option 1E5 installed, and has been disconnected from the mains power. This error should go away after a short warm-up period.

If the synthesizer MSG annunciator is on, there is a problem with the synthesizer. To determine the error and turn off the MSG annunciator, refer to “To Read the Contents of the Error Queue” in Chapter 2 and the listing of error messages in Chapter 8.

Self Test Failures

If the Self Test Fails:

- Check the contents of the error queue for error messages.

To determine errors and clear them, refer to “To Read the Contents of the Error Queue” in Chapter 2 and the listing of error messages in Chapter 8.

Installing and Verifying the Synthesizer

Performing Fundamental Synthesizer Operations

Performing Fundamental Synthesizer Operations

This chapter describes fundamental synthesizer operations. The purpose of this chapter is to familiarize you with the fundamental operation of the synthesizer. Procedures cover how to enter or modify data, how to set the HP-IB address, how to save and recall instrument states, etc.

NOTE

This product has been designed and tested in accordance with IEC Publication 1010, Safety Requirements for Electronic Measuring Apparatus, and has been supplied in a safe condition. The instruction documentation contains information and warnings which must be followed by the user to ensure safe operation and to maintain the product in a safe condition.

WARNING

If this product is not used as specified, the protection provided by the equipment could be impaired. This product must be used in a normal condition (in which all means for protection are intact) only.

To Enter Data with the Numeric Keypad

The synthesizer numeric keypad and units terminator keys provide one way to enter function parameters.

1. Select the desired function key or shifted function key.

The function must have a numeric value (parameter) associated with it in order to enter a new value with the numeric keypad. **FREQ** and **POWER LEVEL** are examples of functions with parameters.

For example, to select power level so that its parameter is active, press the **POWER LEVEL** key.

Notice that a cursor (▼) appears over one of the digits in the power level display. The cursor will always appear over one of the digits of the active parameter.

NOTE

Two cursors will appear (▼▼) when the cursor is positioned off the display.

2. Enter the desired value of the parameter by pressing the numeric keys and, if necessary, the negative and decimal keys.

Notice that, as you press the keys, the display shows the numbers that are entered.

3. Press the appropriate units terminator key to enter the value.

The units terminator keys appear to the right side of the numeric keypad.

The following steps show how to enter a value of -9.5 dBm for power level:

- a. Press the **POWER LEVEL** key.
- b. Press **-9.5** on the numeric keypad.
- c. Press the dBm (**GHz**) key to terminate the entry.

Once you terminate the entry, the synthesizer updates the power level value to -9.5 dBm.

To Modify Data with the Knob

The knob on the synthesizer front panel is used to modify data. You turn the knob in order to increase or decrease the parameter value of the currently active function. Additionally, you can modify the position of the cursor (▼) that is over the active parameter in order to increase or decrease the rate at which the function parameter changes.

1. **Select the function key of the parameter to be modified.**

When the function key is selected, the cursor appears over one of the digits of the selected parameter.

For example, to select the frequency function, press the **FREQ** key. The frequency parameter is selected when the cursor appears over one of the digits of the frequency display.

2. **Turn the knob clockwise to increase the parameter or counterclockwise to decrease the parameter.**

When you turn the knob, the digit under the cursor increases or decreases in steps of one.

For example, when frequency is in its preset state and is the active parameter, the frequency display shows the following:

3.00000000 GHz



where the cursor appears over the third “0” to the right of the decimal. When you turn the knob in this case, the output frequency changes in 1 MHz steps.

3. **If you wish to move the position of the cursor one position to the right, press the **⇒** key.**

Pressing **⇒** once moves the position of the cursor to the right one digit in order to decrease the knob resolution by a factor of ten.

4. **If you wish to move the position of the cursor one position to the left, press the **⇐** key.**

⇐ moves the position of the cursor to the left one digit in order to increase the knob resolution by a factor of ten.

5. Continue to press the  or  key until the cursor is positioned over the desired digit.

For example, suppose that frequency is the current active parameter, and you wish to change the cursor position from 1 MHz to 1 GHz. The steps that follow illustrate how to accomplish this:

- a. Press the  key.



When the instrument has been set to the preset state, the frequency display indicates the following:

3.000000000 GHz

where the cursor appears over the third “0” to the right of the decimal.

- b. Press the  key three times. This moves the cursor from the position corresponding to MHz to the position corresponding to GHz. (The cursor is now over the “3”.)
- c. Rotate the knob slowly so that you can see the frequency change in 1 GHz steps.

NOTE

The Knob and ,  keys operate independently of each other. The ,  keys increase or decrease parameters in defined steps.

To Modify Data with the Arrow Keys

The synthesizer \uparrow and \downarrow (arrow) keys increase or decrease the value of the currently active parameter by an amount set with the **STEP SIZE** key. The amount set with the **STEP SIZE** key is referred to as the increment value.

1. Select the function key of the parameter to be modified.

When the function key is selected, a cursor (\blacktriangledown) appears over one of the digits of the selected parameter.

For example, to select the frequency function, press the **FREQ** key. The frequency parameter is selected when the cursor appears over one of the digits of the frequency display.

2. Press the \uparrow key to increase the parameter by the current increment value or press the \downarrow key to decrease the parameter by the current increment value.

For example, when frequency is in its preset state, the frequency display shows the following:

3.000000000 GHz

where the cursor appears over the third “0” to the right of the decimal. The preset frequency increment value is 100 MHz. When you press the \uparrow key, the value of frequency increases to 3.100000000 GHz.

3. If you wish to change the increment value, you can do so using the **STEP SIZE** key.

The **STEP SIZE** key allows you to change the increment value of the currently active function. For example, suppose that frequency is the current active parameter, and you wish to change the increment value from its preset value of 100 MHz to 250 MHz. The steps that follow illustrate how to accomplish this:

- a. Press the **STEP SIZE** key.
- b. Type **250** on the synthesizer numeric keypad.

- c. Terminate the frequency increment value entry by pressing the **MHz** key.

When either the **↑** or **↓** key is pressed, the frequency will be either increased or decreased by 250 MHz instead of 100 MHz.

NOTE

The knob and **↑**, **↓** keys operate independently of each other. The knob increases or decreases the digit in the display that is under the cursor.

To Save and Recall Synthesizer States

When you use the synthesizer for a specific application, you can save and then recall the instrument state for future use. You can save up to ten different instrument states.

1. Press the **(SHIFT)** key and then the **(RECALL)** (SAVE) key.

When **(SHIFT)**, **(RECALL)** (SAVE) is pressed, the text SAVE STATE IN REG XXX is shown on the synthesizer display where XXX is the last register number entered.

2. Use the numeric keypad to enter the desired register number.

Valid register numbers are 0 through 9.

3. Press the **(Hz)** (ENTER) key to terminate the entry.

4. To recall the instrument state from memory, press the **(RECALL)** key.

When **(RECALL)** is pressed, the text RECALL STATE FROM REG XX is shown on the synthesizer display where XX is the last register recalled.

5. Use the numeric keypad to enter the desired register number.

6. Press the **(Hz)** (ENTER) key to terminate the entry.

Notes

1. When an instrument state is saved to an instrument state register, it will write over any instrument state previously stored to that register.
2. If an instrument state has not been previously stored to an instrument state register, the synthesizer will be set to the preset state if you attempt to recall the instrument state from that register.

Programming Example

Use the following commands to store the instrument state to register 9 and then recall it from register 9:

```
OUTPUT 719; "*SAV 9"  Saves the current instrument state to register #9.  
OUTPUT 719; "*RCL 9"  Recalls the previously stored instrument state  
                        from register #9.
```

To Read the Contents of the Error Queue

When one or more error messages are stored in the synthesizer error queue, the front panel MSG LED annunciator will light. Once all error messages have been read and all error conditions have been corrected, the MSG annunciator will turn off.

1. Press the **MSG** key.

When the **MSG** key is pressed, the most recent uncleared manual error number and the front panel error message will appear on the display.

2. Look up the manual error number in the table in Chapter 8.

Chapter 8 is organized in ascending manual error number order.

3. Perform the instructions following the error message in the list to correct or clear the error condition.

After you have completed the procedure in the list, return to this procedure to continue.

4. If the MSG LED annunciator is still lit, perform steps 1 through 3 again until the MSG annunciator turns off. If the MSG annunciator is turned off, continue with the next step.

5. Press the **MSG** key one more time.

Pressing the **MSG** key again returns the display to normal operation.

NOTE

In the case of unlevelled power or unlocked frequency, the MSG LED annunciator may remain lit continuously until the problem is corrected.

Programming Example

To read the entire contents of the error queue, run the following program:

10 DIM B\$(160)	<i>Dimensions array B\$ to accept 160 characters.</i>
20 OUTPUT 719; "SYST:ERR?"	<i>Queries the oldest uncleared error number and message in the HP-IB error queue.</i>
30 ENTER 719; A,B\$	<i>Enters the error number into variable A and the HP-IB error message into variable B\$.</i>
40 PRINT A,B\$	<i>Prints the error number and HP-IB error message to the controller screen.</i>
50 IF A<>0 THEN 20	<i>Returns to line 20 if there are more errors in the queue.</i>
60 END	

To Set the HP-IB Address

The synthesizer default HP-IB address is preset to 19. You can, however, change the HP-IB address of the synthesizer from the front panel.

1. Press the **(SHIFT)** key on the synthesizer front panel.
2. Press the ADDRESS **(LOCAL)** key.

The display indicates HP-IB ADDRESS XX when the **(LOCAL)** key is pressed where XX is the current HP-IB address.

3. Enter the desired HP-IB address using the numeric keypad.

For example, if you want to set the synthesizer HP-IB address to 12, type **(12)** on the numeric keypad.

The display indicates HP-IB ADDRESS 12.

4. Terminate the HP-IB address entry by pressing the **(Hz)** (ENTER) key.

Note that when **(Hz)** (ENTER) is pressed, the cursor appears over the address parameter in the display. The synthesizer HP-IB address is now set to the new value (12 in the example), but you can still change it with the numeric keypad, knob, or arrow keys at this point. Pressing **(Hz)** (ENTER) again returns the display to normal operation.

Programming Example

To set the synthesizer HP-IB address to 12, send the following command:

```
OUTPUT 719; "SYST:COMM:GPIB:ADDR 12" Sets the synthesizer HP-IB address to 12.
```





If You Encounter a Problem

If you have a problem operating the synthesizer, check the following list of commonly encountered problems and troubleshooting procedures. If the problem that you encounter is not in the following list, contact the nearest Hewlett-Packard office for assistance.



NOTE

When transporting the product, use original packaging or comparable only.



Data Entry Problems

If the data entry controls (keypad, knob, , , ,  keys) do not respond:

- Check that the ENTRY OFF function is not enabled.

The ENTRY OFF function is not enabled when the cursor () appears over any of the parameters in the display. To return to normal entry mode, press the desired function key which has a numeric parameter associated with it (for example, press  if you want to enter frequency).

- Check that the function key which is selected accepts data.

For instance,  accepts data, but,  does not.

- Check that the synthesizer is in the local (not remote) operating mode.

If the synthesizer is in the remote operating mode, the RMT annunciator will be lit. Press the  key on the front panel to return the synthesizer to local operating mode.

If You Encounter a Problem

If no cursor (▼) appears over a parameter in the display:

- Check that the **ENTRY OFF** function is not enabled.

The **ENTRY OFF** function is enabled when the cursor (▼) doesn't appear over any of the parameters in the display. To return to normal entry mode, press the desired function key which has a numeric parameter associated with it (for example, press **FREQ** if you want to enter frequency).

If the parameter you are trying to enter is not accepted by the synthesizer:

- Ensure that you are not trying to set the parameter greater than or less than its limit. Refer to the specification table in this manual for the parameter limits.

- Check that the **MSG LED** annunciator is off.

If the synthesizer **MSG** annunciator is on, there is a problem with the synthesizer. To determine the error and turn off the **MSG** annunciator, refer to “To Read the Contents of the Error Queue” in this chapter and the listing of error messages in Chapter 8.

If the synthesizer does not display/output the carrier frequency entered:

- Check that the frequency multiplier value entered is the expected value.

When a multiplier value other than one is entered, the frequency resolution of the signal before multiplication must be obeyed. For example, for a desired frequency of 40 GHz using a multiplier value of three, the synthesizer would have to output a frequency of 13.33333333 GHz. Since frequency resolution at that frequency is 1 kHz, the closest the synthesizer can set the frequency is 13.333333000 GHz. This yields 39.999999000 GHz after multiplication, not 40 GHz.

Programming Problems

If the synthesizer does not respond to programming commands:

- Refer to the procedure, “To Set the HP-IB Address,” in this chapter to check and, if necessary, change the HP-IB address.

Performing Fundamental Synthesizer Operations

Generating Signals with the Synthesizer

Generating Signals with the Synthesizer

This section provides procedures for generating signals with the HP 83711A/12A or 83711B/12B. The steps in the procedures assume that you are familiar with the fundamental synthesizer operations. Refer to Chapter 2, “Performing Fundamental Synthesizer Operations,” if you are not familiar with these.

Procedures in this chapter include how to generate CW signals, how to use external automatic level control, and how to use the level correct routine.

The procedures in this chapter are, in general, listed in order of increasing complexity.

To Generate a CW Signal

You can generate a CW (continuous wave) signal with no modulation characteristics.

1. Press **PRESET** to set the synthesizer to the default state.
2. Set the desired frequency.

For example, perform the following procedure to set the frequency to 2.000203 GHz.

- a. Press the **FREQ** key.
 - b. Type **2.000203** on the synthesizer's numeric keypad.
 - c. Terminate frequency entry by pressing the **GHz** key.
3. Set the desired RF output power level.

For example, perform the following procedure to set the output power level to 2.5 dBm.

- a. Press the **POWER LEVEL** key.
- b. Type **2.5** on the synthesizer's numeric keypad.
- c. Terminate the power level entry by pressing the **GHz** (dBm) key.

To Generate Millimeter Signals

By using external equipment with the synthesizer, you can generate millimeter-wave signals.

Generating millimeter-wave signals uses the following external equipment.

Equipment	Requirements
Microwave Amplifier	Must be compatible with the HP 8355X Source Module used.
HP 8355X Source Module	Must be capable of generating the desired frequency.

In addition, you must supply any cables and adapters necessary to connect the equipment.

1. Connect the equipment as shown in Figure 3-1:

CAUTION

Turn off the AC power to the microwave amplifier prior to connecting or disconnecting the source module interface cable.

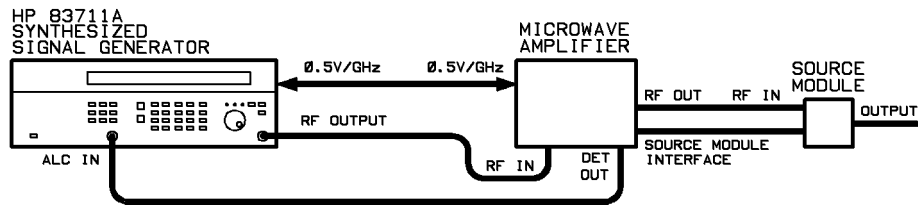

Figure 3-1. Millimeter-Wave Equipment Setup

2. Enter the proper multiplier value for the HP 8355X-series source module that you are using into the synthesizer.

Perform the following procedure to select and enter the proper multiplier value.

- a. Press the **(SHIFT)** key.
- b. Press the **(FREQ)** key.

- c. Press the numeric key on the synthesizer numeric keypad that corresponds to the proper multiplier value from the following table:

Source Module Model Number	Frequency Band	Multiplier Value
HP 83554A	26.5 - 40 GHz	2
HP 83555A	33 - 50 GHz	3
HP 83556A	40 - 60 GHz	3
HP 83557A	50 - 75 GHz	4
HP 83558A	75 - 110 GHz	6

- d. Terminate the multiplier value entry by pressing the **(Hz)** (ENTER) key.
3. Set the frequency for the desired output signal.
- The synthesizer frequency display will show the frequency at the output of the millimeter source module, not the synthesizer RF OUTPUT connector.
- For example, if you want to generate a 30 GHz CW only signal, perform the following steps:
- Press the **(FREQ)** key.
 - Type **(30)** on the numeric keypad.
 - Press the **(GHz)** key to terminate the entry.
4. If the RF output is currently turned off, press the **(RF ON/OFF)** key to turn it on.
- If the RF output is off, the word OFF appears in the power level portion of the right-most display.
5. Press the **(INT LEVEL)** key to enable internal leveling.
6. Set the approximate desired RF output power at the output of the millimeter source module using the display on the microwave amplifier.
- For example, to set the level to 0 dBm, press **(POWER LEVEL)** and rotate the synthesizer knob until "0 dBm" is shown on the microwave amplifier display.
7. Press the **(EXT DIODE)** key.

To Generate Millimeter Signals

8. Set the RF output power level desired at the output of the millimeter source module using the display on the microwave amplifier.

The display on the microwave amplifier shows the power level at the output of the source module to within ± 2 dB. You should use the display on the microwave amplifier, not the synthesizer, when adjusting the RF output power. For example, to set the output power level to 0 dBm, press the **(POWER LEVEL)** key and rotate the knob until “0 dBm” is shown on the microwave amplifier display.

NOTE

The knob resolution can be changed using the **(⇒)** and **(⇐)** keys. However, the multiplied signal frequency resolution is further limited due to the multiplier value used. For example, if the multiplier value is set to 3 and the synthesizer baseband resolution is 1 kHz, the resulting resolution is 3 kHz.

To Use External Diode Detector Leveling

External diode detector leveling is useful when you desire leveled RF output power from the synthesizer at a point other than the RF OUTPUT connector.

External diode detector leveling uses the following external equipment.

Equipment	Requirements
Diode Detector	Must be specified for use at the desired synthesizer output frequency. Must produce greater than 1 mv of ALC voltage for the power levels present at the sampling point. Detector can be either positive or negative.
Power Splitter <i>or</i> Directional Coupler	Must be specified for use at the desired synthesizer output frequency.
Power Meter <i>(optional)</i>	None.
Power Sensor <i>(optional)</i>	Must be capable of measuring power at the frequency and level present at the sampling point in the leveling loop.
Cables and Adapters	You must supply the cables and adapters necessary to connect the equipment.

NOTE

The power meter and power sensor are not required, but are helpful when adjusting the synthesizer output power for the desired power level at the output.

To Use External Diode Detector Leveling

In addition, you must supply the cables and adapters necessary to connect the equipment.

1. Connect the equipment as shown in Figure 3-2:

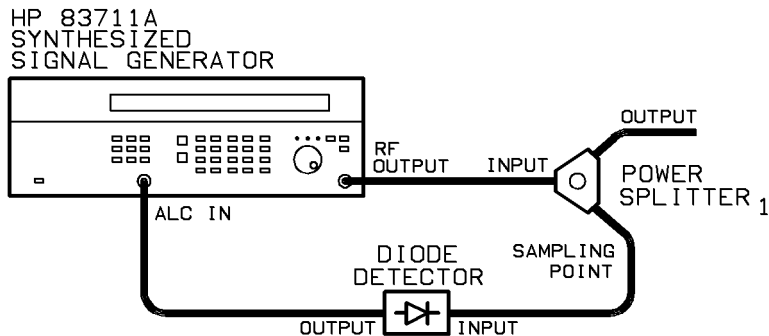

¹ A DIRECTIONAL COUPLER CAN BE USED IN PLACE OF THE POWER SPLITTER.

Figure 3-2. External Diode Detector Leveling Setup

2. Press the **(EXT DIODE)** key to enable external leveling.

NOTE

When the **(EXT DIODE)** key is pressed, the synthesizer enters the external diode detector leveling mode. Power is then held at a constant level at the sampling point, regardless of gain changes in the signal path between the synthesizer RF OUTPUT connector and the output.

3. Set the desired output signal frequency using the **(FREQ)** key and any modulation.
4. If the RF output is currently turned off, press the **(RF ON/OFF)** key to turn it on.

(If the RF output is off, the word OFF appears in the power level portion of the right-most display.)

5. Adjust the synthesizer output power so that the desired power at the output is attained.

For example, assume that you are using a power splitter and you want -5 dBm at the output of the splitter. In this case, you must set the power at the output to -5 dBm. Perform the following procedure to set the power at the output to -5 dBm.

- a. Temporarily connect the power meter and sensor at the output.
- b. Press the **POWER LEVEL** key.
- c. Rotate the knob until the power meter reads -5 dBm (disregard the synthesizer power level reading).
- d. Disconnect the power meter and sensor from the output and connect the device under test (DUT).

Notes

1. When the **EXT DIODE** key is pressed, the synthesizer output power might change. Therefore, you might want to check the output power and readjust if necessary.
2. External diode detector leveling does not provide temperature compensation, thus, output level recalibration might be required in environments that are not temperature stabilized.
3. External diode detector leveling does not provide proper compensation from square law to linear regions of the detector. Therefore, power level changes may require output level recalibration.

Programming Command

The following command is related to external diode detector leveling.

`POW:ALC:SOUR DIOD` *Enables external diode detector leveling.*

Related Tasks

- To Use External Power Meter Leveling

To Use External Power Meter Leveling

External power meter leveling is useful when you desire leveled RF output power from the synthesizer at a point other than the RF OUTPUT connector.

External power meter leveling requires the following external equipment.

Equipment	Requirements
Power Meter	Must have a recorder output and range hold capability.
Power Sensor	Must be capable of measuring power at the frequency and level present at the sampling point in the leveling loop.
Power Splitter <i>or</i> Directional Coupler	Must be specified for use at the desired synthesizer output frequency.

In addition, you must supply the cables and adapters necessary to connect the equipment.

1. Connect the equipment as shown in Figure 3-3:

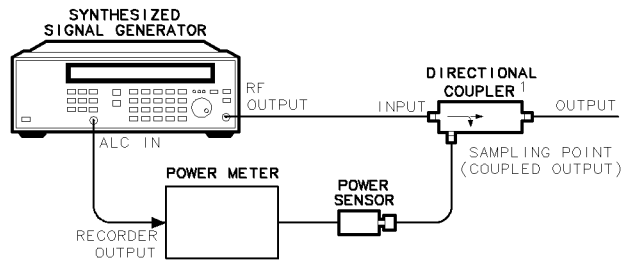

1. A POWER SPLITTER CAN BE USED IN PLACE OF THE DIRECTIONAL COUPLER.

pg67ab

Figure 3-3. External Power Meter Leveling Setup

2. Press the **(INT LEVEL)** key to enable internal leveling.
3. Set the desired output signal frequency using the **(FREQ)** key.

To Use External Power Meter Leveling

4. Set the desired output power level using the **(POWER LEVEL)** key.
5. If the RF output is currently turned off, press the **(RF ON/OFF)** key to turn it on.

If the RF output is off, the word OFF appears in the power level portion of the display.

6. Select auto range on the power meter.
7. Modify the synthesizer output power so that the power meter display indicates the power desired at the sampling point.

For example, assume that you are using a directional coupler that has a coupling factor of 22 dB and you want +5 dBm at the output of the coupler. In this case, you must set the power at the sampling point (the coupled output) to -17 dBm. Perform the following procedure to set the power at the sampling point to -17 dBm.

- a. Press the **(POWER LEVEL)** key.
 - b. Rotate the knob on the synthesizer until the power level displayed on the power meter is -17 dBm. Disregard the power level shown on the synthesizer display.
8. Select range hold on the power meter.
 9. Press the **(EXT METER)** key on the synthesizer.

When the **(EXT METER)** key is pressed, the text **RNG-HOLD, POWER XXXdBm** appears in the display, where XXX is the last range hold meter value that was entered.

10. Enter the power shown on the power meter display into the synthesizer using the numeric keypad.

The value entered into the synthesizer is called the range hold meter value. For example, if the power meter currently reads -17 dBm, perform the following procedure to enter -17 dBm into the synthesizer:

- a. Type **(-17)** on the synthesizer numeric keypad.
- b. Terminate the range hold meter value entry by pressing the **(GHz)** (dBm) key.

When the range hold meter value is terminated, the synthesizer enters the external power meter leveling mode. Power is then held at a constant level at the sampling point, regardless of gain changes in the signal path between the synthesizer RF OUTPUT connector and the sampling point.

Programming Commands

The following commands are related to external power meter leveling.

<code>POW:ALC:PMET <u>reading</u></code>	<i>Reads the initial power meter reading into the synthesizer. The initial power meter reading is defined by the “reading” parameter.</i>
<code>POW:ALC:SOUR PMET</code>	<i>Enables external power meter leveling.</i>

Related Tasks

- To Use External Diode Detector Leveling

To Use the Level Correct Routine

When activated, the level correct function adjusts the synthesizer output power (to compensate for losses or gains) to provide constant, leveled power at output of the external signal path.

When the level correct routine is used, the synthesizer performs a calibration process that corrects for external losses or power variations in an external signal path. When the level correct routine is run, a power meter that is under control of the synthesizer will measure power variations at the output of the external signal path over a user-defined frequency range. The synthesizer then reads back the power level data from the power meter and creates a table of correction values for each frequency point (the level correction table).

The level correction table resides in non-volatile memory and up to four level correction tables can be stored for later use. If the power meter is in a favorable range, the level correct routine takes approximately two minutes to run.

NOTE

When using the level correct routine, the external path to the synthesizer must be linear (must have a 1 dB per 1 dB transfer function).

Using the level correct routine requires the following external equipment.

Equipment	Requirements
HP 437B, 438A, 70100A, or SCPI compatible power meter Power Sensor	No substitute. Must be compatible with the power meter used. Must be capable of measuring power at the frequencies and levels present at the output of the signal path being leveled.

In addition, you must supply the cables and adapters necessary to connect the equipment.

1. Connect the equipment as shown in Figure 3-4:

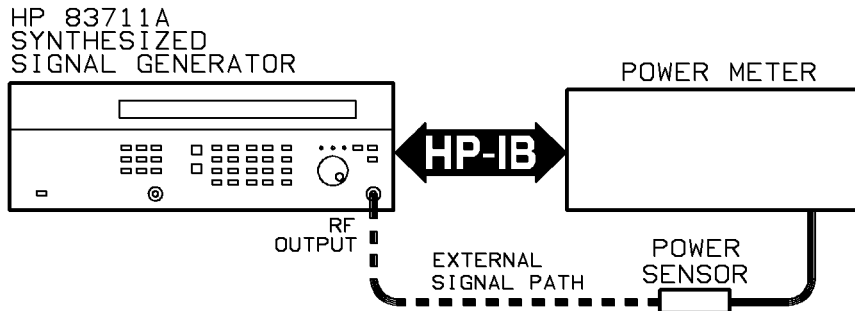

Figure 3-4. Level Correct Routine Equipment Setup

2. Set the address that the synthesizer will use to address the power meter during the level correct routine.

For example, use the following procedure to set the power meter address to 23.

- a. Press the **(SPCL)** key.
 - b. Type **(20)** on the synthesizer numeric keypad.
 - c. Press the **(Hz)** (ENTER) key. You will be prompted to enter the power meter address.
 - d. Type **(23)** on the synthesizer numeric keypad.
 - e. Terminate the power meter address by pressing the **(Hz)** (ENTER) key.
3. Choose the programming language that the synthesizer will use to communicate with the power meter over the HP-IB.

For example, use the following procedure to choose HP 437B compatible programming language.

- a. Press the **(SPCL)** key.
- b. Type **(21)** on the synthesizer numeric keypad.
- c. Press the **(Hz)** (ENTER) key.

To Use the Level Correct Routine

- d. Press the \uparrow or \downarrow key until the display reads POWER METER IS HP437B.
4. Press the **POWER LEVEL** key.
5. Adjust the power level to a level near the center of the power sensor range.
6. Press the **SHIFT** key and then the **INT LEVEL** (LVL CR) key.

When **SHIFT**, **INT LEVEL** (LVL CR) is pressed, the words COR START XXX appear in the left-most display where XXX is the current level correct start frequency.

7. Enter the desired level correct start frequency. If the start frequency shown in the display is the desired start frequency, continue with step 8.

For example, use the following procedure to set the level correct start frequency to 3.5 GHz.

- a. Type **3.5** on the synthesizer numeric keypad.
- b. Terminate the level correct start frequency by pressing the **GHz** key.

Note that the level correct start frequency remains on the display after it is terminated so that it can be modified using the knob or \uparrow , \downarrow keys if desired.

8. Press the **Hz** (ENTER) key to begin level correct stop frequency entry.

When the **Hz** (ENTER) key is pressed, the words COR STOP XXX appear in the left-most display where XXX is the current level correct stop frequency.

9. Enter the desired level correct stop frequency. If the stop frequency shown in the display is the desired stop frequency, continue with step 10.

For example, use the following procedure to set the level correct stop frequency to 9.75 GHz.

- a. Type **9.75** on the synthesizer numeric keypad.
- b. Terminate the level correct stop frequency by pressing the **GHz** key.

Note that the level correct stop frequency remains on the display after it is terminated so that it can be modified using the knob or \uparrow , \downarrow keys if desired.

10. Press the $\boxed{\text{Hz}}$ (ENTER) key to begin the number of points entry.

When the $\boxed{\text{Hz}}$ (ENTER) key is pressed, the words SET NUMBER OF POINTS XXX appear in the left-most display where XXX is the current number of points. A maximum of 401 points can be entered.

11. Enter the desired number of points. If the number of points shown in the display is the desired number of points, continue with step 12.

Note that the start frequency and stop frequency are included in the number of points. Use the following procedure to set the number of points to 100, for example.

- a. Type $\boxed{100}$ on the synthesizer numeric keypad.
- b. Terminate the number of points entry by pressing the $\boxed{\text{Hz}}$ (ENTER) key.

Note that the number of points entry remains on the display after it is terminated so that it can be modified using the knob or \uparrow , \downarrow keys if desired.

12. Press the $\boxed{\text{Hz}}$ (ENTER) key.

When the $\boxed{\text{Hz}}$ (ENTER) key is pressed, the words RUN CORRECTION?, HIT ENTER appear in the left-most display

13. Press $\boxed{\text{Hz}}$ (ENTER) to run the level correct routine.

The level correct routine can be aborted before it begins running by pressing the $\boxed{\text{LOCAL}}$ key. It can also be aborted any time while it is running by pressing the $\boxed{\text{LOCAL}}$ key.

As the level correct routine is running, the right-most display will be blanked and the left-most display will show each frequency point and measured power level as each measurement occurs. When the level correct routine has finished running, the left-most display will blank and the frequency and output power level will return to the right-most display.

To Use the Level Correct Routine

NOTE

As the routine is running, the synthesizer sends the power meter each frequency point so that the correct calibration factor at each frequency can be used.

For best accuracy, the correct calibration factors for the power sensor being used should be entered into the power meter prior to running the level correct routine.

14. When the level correct routine has finished running, press the **(SHIFT)** key and then the **(POWER LEVEL)** (LVL CR ON/OFF) key to enable the synthesizer to use the level correct data when determining the output power level.

When the level correct data has been enabled, the LVL CR annunciator will be lit.

15. Disconnect the power meter and power sensor from the level correct setup.

The output of the external signal path can now be connected to the device under test.

The data stored in non-volatile memory will only be valid for the current external signal path. If the external signal path is changed, the level correct routine will have to be rerun.

NOTE

The table of level correct values should be stored in one of four level correction register locations for later use.

To store the table of level correct values in a level correction register location, perform the following procedure.

1. Press the **(SHIFT)** key and then the **(INT LEVEL)** (SAVE CR) key.

The display will show SAVE IN TABLE XXXX where XXXX is the current level correction register number.

2. Enter the desired level correction register number.

For example, use the following procedure to choose level correction register number 2.

- a. Type **(2)** on the synthesizer numeric keypad.
- b. Terminate the level correction register number entry by pressing the **(Hz)** (ENTER) key.

NOTE

Once the level correction register number entry has been terminated, the current table of level correct values will write over any old level correct data stored at that register location.

Related Tasks

- To Use Previously Stored Level Correct Data

To Use Previously Stored Level Correct Data

When the level correct routine is run, the synthesizer creates a table of correction values for each frequency point in the table. Up to four level correction tables can be stored in the synthesizer memory. If the current signal path at the synthesizer output (the external signal path) is identical to the external signal path on which a level correct routine had been previously run, the level correction table can be recalled from memory and be used at a later time.

1. Verify that the current external signal path is correct for the level correct table you want to recall from memory and use.

The current external signal path must be identical to the external signal path that was calibrated and stored in the level correct table that you wish to recall. If the current external signal path is different, the data can cause inaccurate output power levels at the output of the external signal path.

2. Press the **SHIFT** key and then the **EXT METER** (RCL CR) key.

The display will show RECALL FRM TABLE XXX where XXX is the last level correction register number recalled.

3. Enter the level correction register number of the register that contains the level correct data you want to use.

For example, use the following procedure to choose level correction register number 2.

- a. Type **2** on the synthesizer numeric keypad.
 - b. Terminate the level correction register number entry by pressing the **Hz** (ENTER) key.
4. Press the **SHIFT** key and then the **POWER LEVEL** (LVL CR ON/OFF) key to enable the synthesizer to use of level correct data when determining the output power level.

When the use the level correct data has been enabled, the LVL CR annunciator will be lit.

Related Tasks

- To Use the Level Correct Routine

If You Encounter a Problem

If you have a problem generating signals with the synthesizer, check the following list of commonly encountered problems and troubleshooting procedures.

If the problem involves data entry, check the section in Chapter 2 entitled, “If You Encounter a Problem.” If the problem that you encounter is not in the following list or in Chapter 2, contact the nearest Hewlett-Packard office for assistance.

Annunciators Turned On

If the UNLVL LED annunciator is on:

- Check the leveled power specification to make sure that you have not exceeded the specification.

The maximum power specification is frequency dependent. Typically less maximum power is available as the synthesizer output frequency is increased.

- If external diode detector leveling or external power meter leveling is being used, ensure that the leveling loop is not opened.
- If external diode detector leveling or external power meter leveling is being used, ensure that the synthesizer output is not being forced into an unleveled condition by the leveling circuitry.

If the circuit path before the sampling point has a lot of attenuation, the synthesizer will have to source high power even though the required power at the sampling point seems low. For example, if the circuit before the sampling point has 23 dB of attenuation and the power required at the sampling point is 5 dBm, the synthesizer will need to source 28 dBm, which is more than its maximum specified power level.

If the MSG LED annunciator is on:

If the synthesizer MSG annunciator is on, there is a problem with the synthesizer. To determine the error and turn off the MSG annunciator, refer to “To Read the Contents of the Error Queue” in Chapter 2 and the listing of error messages in Chapter 8.

RF Output Problems

If there is no signal at the RF Output connector:

- Check that the signal at the RF OUTPUT connector is turned on.

If the RF OUTPUT connector is turned off, the text OFF will be displayed in place of dEM in the right-most display.

If the signal at the RF OUTPUT connector is turned off, press the **RF ON/OFF** key once to turn it on.

If the signal at the RF OUTPUT connector does not appear to be phase locked to the external reference:

- Check that the external reference is within synthesizer specifications. Refer to the Specification table in Chapter 4 for the external reference input specifications.

Generating Signals with the Synthesizer

Specifications and Options

Specifications and Options

This chapter contains listings of the synthesizer performance specifications and the mechanical, electrical, warranty, and documentation options that are available.

Specifications for each instrument appear under the instrument number, further on in this chapter. The general specifications given here apply equally to the HP 83711A/12A and HP 83711B/12B.

HP 83711A/11B Specifications

Specifications describe the instrument's warranted performance over the 0° to 55° temperature range unless otherwise noted. Supplemental characteristics, *indicated by italics*, are intended to provide information useful in estimating instrument capability in your application by describing typical, but not warranted, performance.

Frequency

Range: 1.0 to 20.0 GHz

Resolution: 1 kHz (1 Hz with Option 1E8)

Stability (with high stability timebase, Option 1E5):

Aging Rate: $<1.5 \times 10^{-9}$ /day after 24-hour warm up.

Temperature Effects: $<1 \times 10^{-7}$ over 0 to 55 °C, nominally $<1.4 \times 10^{-9}/^{\circ}\text{C}$

Line Voltage Effects: $<5 \times 10^{-10}$ for 10% change in line voltage

Stability (without high stability timebase):

Aging Rate: $<1.0 \times 10^{-8}$ /day after 72-hours at 25 °C ± 10 °C

Temperature Effects: $<5 \times 10^{-6}$ over 0 to 55 °C referenced to 25 °C

Stability (with external 10 MHz reference):

Same as external reference.

Frequency Switching Time: <50 ms to within 1 kHz

For <1 GHz steps, not across 10 GHz band switch point: <35 ms
(HP 83711B only)

RF Output

Maximum Levelled Output Power (0 °C to +35 °C):

Frequency	Standard	with Option 1E1
1–20 GHz	+11 dBm	+10 dBm

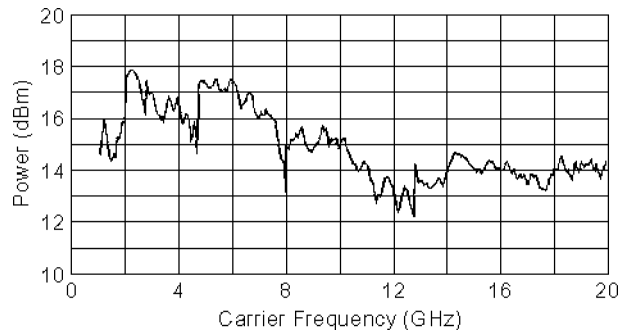

Figure 4-1.
Typical Maximum Available Output Power from 1 to 20 GHz, at 25 °C with Output Step Attenuator (Option 1E1) Installed

Minimum Levelled Output Power (without Option 1E1):
0 dBm

Minimum Levelled Output Power (with Option 1E1):
–110 dBm (–90 dBm on HP 83711A)

Display Resolution:
0.01 dB

Accuracy:

- ±1.0 dB (over all power levels)
(0 dBm to specified maximum leveled output power)
- ±2.0 dB (power ≥ -90 dBm)
- ±2.5 dB (power < -90 dBm)

The use of Type-N RF connectors above 18.0 GHz degrades specification typically by 0.2 dB.

Flatness:

- ±0.5 dB (power ≥ -90 dBm)
- ±0.7 dB (power < -90 dBm)

The use of Type-N RF connectors above 18.0 GHz degrades specification typically by 0.2 dB.

Level Switching Time: <17 ms (without step attenuator range change)

Attenuator range changes occur at:

HP 83711B, HP 83712B -1 dBm, -11 dBm, -21 dBm, etc.)

Output SWR: <2.0 : 1 nominal

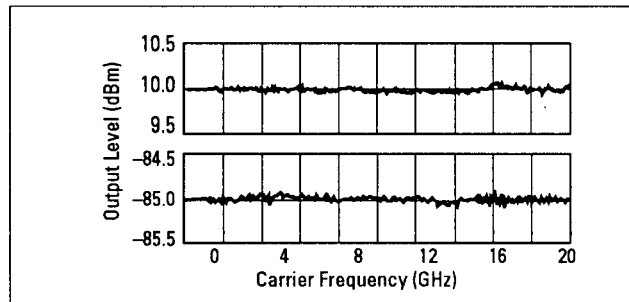

Figure 4-2. Typical Output Level Accuracy and Flatness at +10 and -85 dBm

Spectral Purity

SSB Phase Noise (dBc/Hz):

Table 4-1. Offsets (HP 83711A only)

Carrier Freq.	100 Hz	1 kHz	10 kHz	100 kHz
2 GHz	-66	-74	-91	-107
10 GHz	-69	-75	-79	-101
18 GHz	-63	-70	-73	-99

Table 4-2. Offsets (HP 83711B only)

Carrier Freq.	100 Hz	1 kHz	10 kHz	100 kHz
1 GHz to <2 GHz	-73	-83	-92	-107
2 GHz to <5 GHz	-70	-78	-83	-100
5 GHz to <10 GHz	-69	-78	-82	-100
10 GHz to 20 GHz	-65	-73	-76	-100

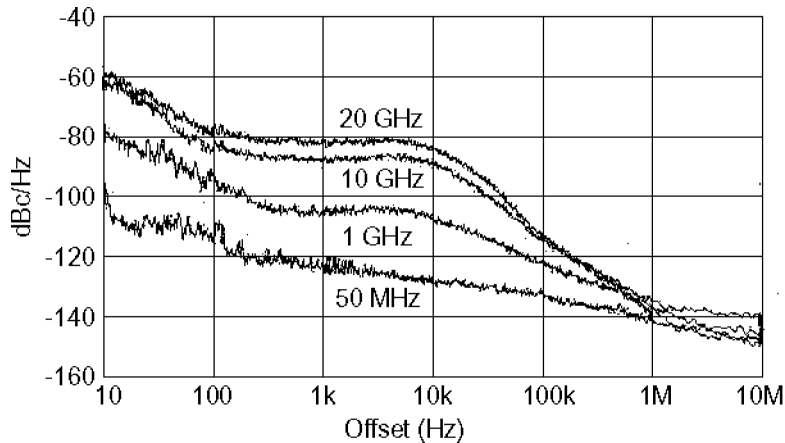

Figure 4-3.

Typical single-sideband phase noise at 1 GHz, 10 GHz and 20 GHz, 25 °C, CW mode. Offsets less than 100 Hz require the high stability timebase, Option 1E5.

Harmonics: < -50 dBc at output levels $< +6$ dBm, 1 to 20 GHz

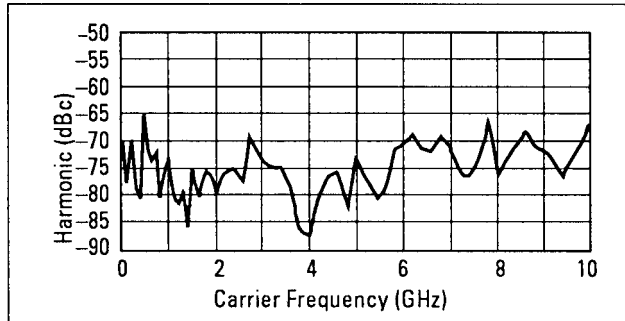

Figure 4-4. Typical 2nd Harmonic Levels Measured at Output Power of +6 dBm

Non-Harmonic Spurious (≥ 3 kHz): < -60 dBc (includes power supply and frequency synthesis spurious)

Non-Harmonic Spurious (< 3 kHz): < -50 dBc

Sub-Harmonics: None

Residual FM:

At 1 GHz, <15 Hz in 50 Hz–15 kHz bandwidth.

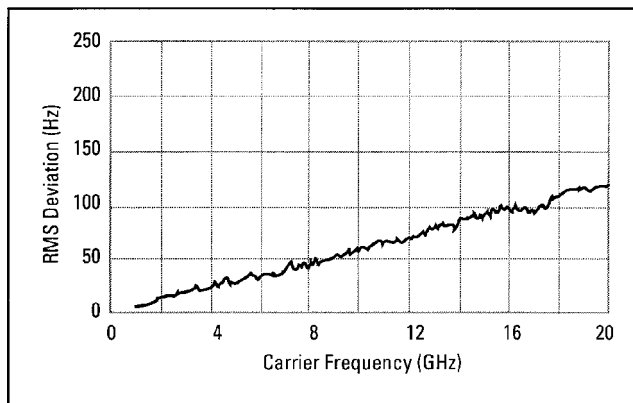

Figure 4-5.
Typical Residual FM Measured in 50 Hz · 15 kHz Bandwidth, CW Mode, with High Stability Timebase (Option 1E5)

*AM Noise Floor: (at 0 dBm and offsets greater than 5 MHz from carrier)
< -150 dBm/Hz*

HP 83712A/12B Specifications

Specifications describe the instrument's warranted performance over the 0° to 55° temperature range unless otherwise noted. Supplemental characteristics, *indicated by italics*, are intended to provide information useful in estimating instrument capability in your application by describing typical, but not warranted, performance.

Frequency

Range: 0.01 to 20.0 GHz

Resolution: 1 kHz (1 Hz with Option 1E8)

Stability (with high stability timebase, Option 1E5):

Aging Rate: $<1.5 \times 10^{-9}$ /day after 24-hour warm up.

Temperature Effects: $<1 \times 10^{-7}$ over 0 to 55 °C, nominally $<1.4 \times 10^{-9}/^{\circ}\text{C}$

Line Voltage Effects: $<5 \times 10^{-10}$ for 10% change in line voltage

Stability (without high stability timebase):

Aging Rate: $<1.0 \times 10^{-8}$ /day after 72-hours at 25 °C ± 10 °C

Temperature Effects: $<5 \times 10^{-6}$ over 0 to 55 °C referenced to 25 °C

Stability (with external 10 MHz reference):

Same as external reference.

Frequency Switching Time: <50 ms to within 1 kHz

For <1 GHz steps, not across 10 GHz band switch point: <35 ms

(HP 83712B only)

RF Output

Maximum Leveled Output Power (0 °C to +35 °C):

Frequency	Standard	with Option 1E1
0.01–1 GHz	+13 dBm	+13 dBm
1–20 GHz	+11 dBm	+10 dBm

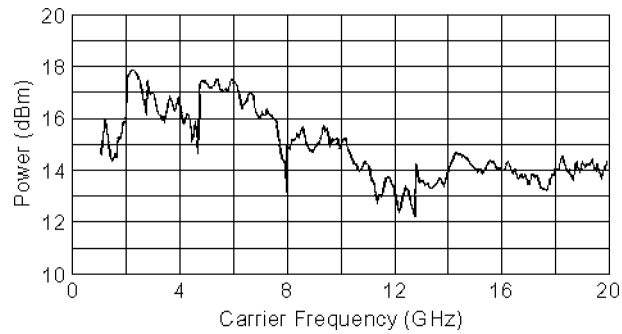

Figure 4-6.
Typical Maximum Available Output Power from 1 to 20 GHz, at 25 °C with Output Step Attenuator (Option 1E1) Installed

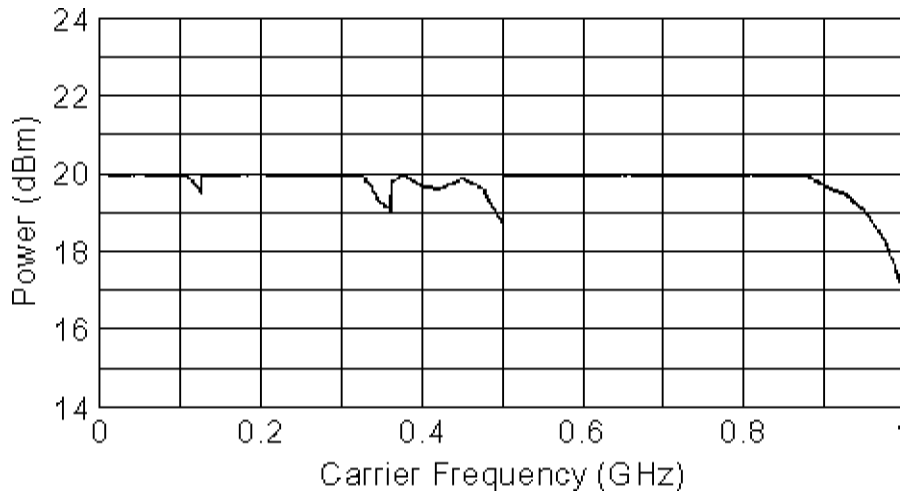

Figure 4-7. Typical Maximum Available Output Power from 0.01 to 1 GHz at 25 °C.

Minimum Leveled Output Power (without Option 1E1): 0 dBm

Minimum Leveled Output Power (with Option 1E1): -110 dBm
(-90 dBm for HP 83712A)

Display Resolution: 0.01 dB

Accuracy: (0 dBm to specified maximum leveled output power)

10 MHz to 50 MHz: ± 1.3 dB

50 MHz to 20 GHz: ± 1.0 dB

Accuracy: (over all power levels)

10 MHz to 50 MHz: ± 2.3 dB (power ≥ -90 dBm)

50 MHz to 20 GHz: ± 2.0 dB (power ≥ -90 dBm)

10 MHz to 20 GHz: ± 2.5 dB (power < -90 dBm)

The use of Type-N RF connectors above 18.0 GHz degrades specification typically by 0.2 dB.

Flatness:

± 0.5 dB (power ≥ -90 dBm)

± 0.7 dB (power < -90 dBm)

HP 83712A/12B Specifications

The use of Type-N RF connectors above 18.0 GHz degrades specification typically by 0.2 dB.

Level Switching Time: <17 ms (without step attenuator range change.

Attenuator range changes occur at -1 dBm, -11 dBm, -21 dBm, etc.)

Output SWR: <2.0 : 1 nominal

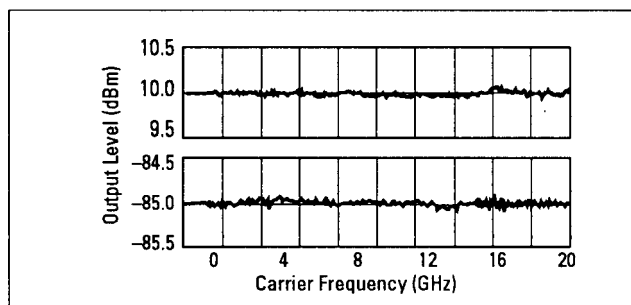

Figure 4.8. Typical Output Level Accuracy and Flatness at +10 and -85 dBm

Spectral Purity

SSB Phase Noise (dBc/Hz):

Table 4-3. Offsets (HP 83712A only)

Carrier Freq.	100 Hz	1 kHz	10 kHz	100 kHz
500 MHz	-70	-86	-103	-119
2 GHz	-66	-74	-91	-107
10 GHz	-69	-75	-79	-101
18 GHz	-69	-70	-73	-99

Table 4-4. Offsets (HP 83712B only)

Carrier Freq.	100 Hz	1 kHz	10 kHz	100 kHz
500 MHz to <1 GHz	-78	-92	-103	-115
1 GHz to <2 GHz	-73	-83	-92	-107
2 GHz to <5 GHz	-70	-78	-83	-100
5 GHz to <10 GHz	-69	-78	-82	-100
10 GHz to 20 GHz	-65	-73	-76	-100

Phase noise decreases 6 dB/octave below 500 MHz and reaches a floor of -140 dBc/Hz.

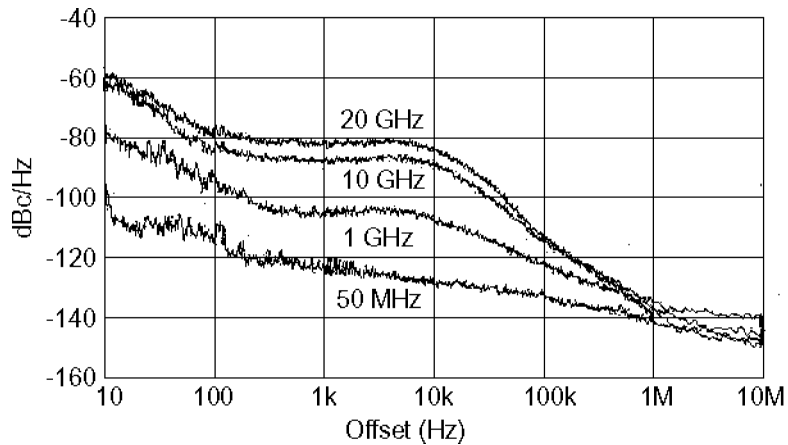
HP 83712A/12B Specifications**Figure 4-9.**

**Typical single-sideband phase noise at 50 MHz, 1 GHz, 10 GHz and 20 GHz, 25 °C, CW mode.
Offsets less than 100 Hz require the high stability timebase, Option 1E5.**

Harmonics: < -55 dBc at output levels $< +6$ dBm, 0.01 to 1 GHz

Harmonics: < -50 dBc at output levels $< +6$ dBm, 1 to 20 GHz

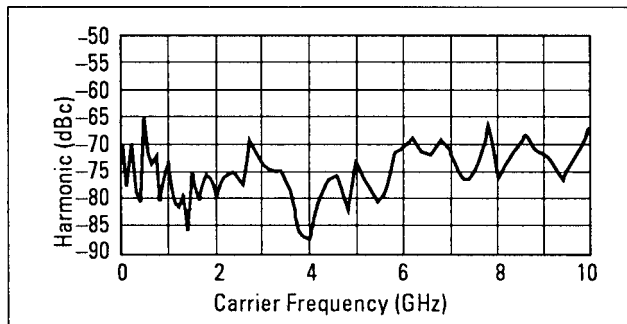

Figure 4-10. Typical 2nd Harmonic Levels Measured at Output Power of +6 dBm

Non-Harmonic Spurious (≥ 3 kHz):

< -60 dBc (includes power supply and frequency synthesis spurious)

Non-Harmonic Spurious (< 3 kHz):

< -50 dBc

Sub-Harmonics: None

HP 83712A/12B Specifications*Residual FM:*

At 1 GHz, <15 Hz in 50 Hz–15 kHz bandwidth. Residual FM decreases 6 dB per octave below 1 GHz.

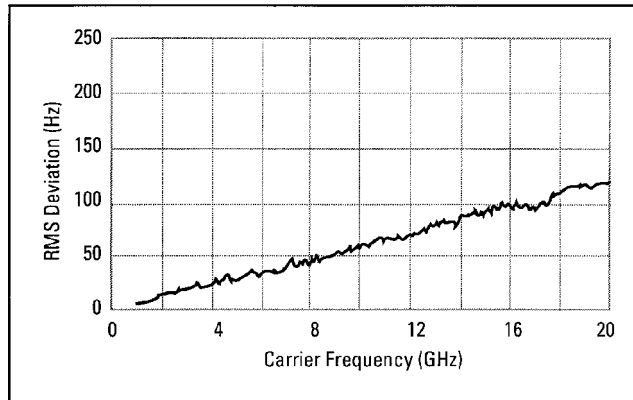

Figure 4-11.
Typical Residual FM Measured in 50 Hz · 15 kHz Bandwidth, CW mode, with High Stability Timebase (Option 1E5)

AM Noise Floor: (at 0 dBm and offsets greater than 5 MHz from carrier)
<-150 dBm/Hz, 1–20 GHz.
<-140 dBm/Hz, 0.01–1 GHz.

General

Programming

The HP 83711A/12A and HP 83711B/12B are fully compatible with the Standard Commands for Programmable Instruments (SCPI). SCPI programming complies with IEEE 488.2-1987. In addition, these synthesizers will emulate most applicable HP 8673 commands, providing general compatibility with ATE systems which include HP 8673 Series signal generators. Refer to the HP 8673 compatibility chapter in the Programming Guide for specific information. Please consult your HP sales representative for details.

Environmental

Operating Temperature Range: 0° to 55 °C (for indoor use).

Altitude: Up to 15,000 feet (4,572 meters).

Relative Humidity: 80% for temperatures up to 31 °C decreasing linearly to 50% relative humidity at 40 °C.

EMC: Complies with CISPR Publication 11/1990, Class A, Group 1 and MIL-STD-461C, Part 2, Methods CE03 (NB full limits, BB 10 dB relaxation 150 kHz to 500 kHz, full limits elsewhere); CS01; CS02; RE02 (Curve 2 + 10 dB); RS03 (1 V/m, 15 kHz to 1 GHz).

This product is designed for use in INSTALLATION CATEGORY II and POLLUTION DEGREE 2, per IEC 1010 and 664 respectively.

Acoustic Noise Emission (Geraeuschemission)

LpA <70 dB(A) per ISO 3744 (LpA <70 dB(A) nach DIN 45635 pt. 1)

LpA Operator position: 44.6 dB, based upon type test per ISO 6081. (LpA am Arbeitsplatz: 44.6 dB, typpruefungsergebnis nach DIN 45635 pt. 19)

LpA Bystander position: 38.4 dB, based upon type test per ISO 6081. (LpA fiktiver Arbeitsplatz: 38.4 dB, typpruefungsergebnis nach DIN 45635 pt. 19)

HP 83712A/12B Specifications

Power Requirements

Power: 90-132V, 48-440 Hz. 198-264V, 48-66 Hz.
260 VA maximum.

Physical Dimensions

Net Weight: < 16 kg (35 lb)

Shipping: < 23 kg (49 lb)

Size: 498 mm D × 426 mm W × 133 mm H (19.6" × 16.8" × 5.2")

Transit case available by ordering HP Part Number 9211-2655.

Front Panel Connectors

RF OUTPUT

The standard front panel RF OUTPUT connector is a Type-N precision connector. When Option 1E9 is installed, this front panel connector is a 3.5 mm precision connector. The nominal source impedance is 50Ω .

ALC IN

This front panel BNC connector allows the synthesizer to be externally leveled. It is used with external power meter leveling or external diode leveling. The leveling signal at this input must be in the $\pm 1V$ range. The nominal input impedance is $150\text{ k}\Omega$. The damage level is $\geq +12\text{ V}$ or $\leq -12\text{ V}$.

Rear Panel Connectors

10 MHz Input

Accepts a 10 MHz \pm 100 Hz, 0 to +10 dBm, external reference signal for operation from an external high stability timebase. Nominal input impedance is 50 Ω .

10 MHz Output

Outputs the 10 MHz reference signal, nominally +3 dBm, for use as an external reference signal. Nominal source impedance is 50 Ω .

0.5V/GHz Output

Supplies a voltage proportional to output frequency for use with mm-wave frequency multipliers, including the HP 83550 Series Millimeter Wave Source Modules.

Options

There are several electrical, mechanical, warranty, and documentation options available for the CW Generator.

Electrical Options

There are four electrical options available for the CW Generator. These options are as follows:

Option 1E1 - Add Output Step Attenuator

If Option 1E1 is ordered, an internal step attenuator is included before the RF OUTPUT connector. The step attenuator has a range of 0 to 110 dB (90 dB for 83711A/83712A) in 10 dB steps (0–110 dB for 11B/12B). The correct amount of attenuation is selected automatically by the CW Generator dependent on the output power level selected. If this option is installed, you can select whether or not the step attenuator will automatically switch. This function is useful during certain applications, such as when external automatic level control is used. <idxadd high stability timebase - option 1E5|

Option 1E5 - Add High Stability Timebase

If Option 1E5 is ordered, the CW Generator is shipped with a 10 MHz temperature controlled crystal reference oscillator for increased frequency accuracy and stability. If Option 1E5 is installed, the CW Generator must be connected to AC mains power to keep the reference oscillator at operating temperature. If the reference oscillator has not been connected to mains power (the oven is cold), the CW Generator requires 30 minutes to warm up.

Option 1E8 - 1 Hz Frequency Resolution

Consult your HP sales representative for details on availability and retrofit information.

Option 1E9 - 3.5 mm RF Output Connector If Option 1E9 is ordered, the **RF OUTPUT** connector is a male APC-3.5 precision connector in place of the standard female Type-N connector.

Mechanical Options

There are three mechanical options available for the synthesizer. If these options were not ordered with the original shipment, a Handle Kit (part number 5062-3989) is included. If a mechanical option is desired later, they can be ordered from the nearest Hewlett-Packard office using the part numbers included in each of the following paragraphs. These options are as follows:

Option 1CM - Rack Mount Kit The synthesizer can be mounted to an instrument rack using the rack mount kit. The Rack Mount Kit part number is 5062-3977.

Option 1CP - Rack Mount and Handle Kit The synthesizer can be mounted to an instrument rack using the rack flange kit.

In addition, ease of handling is increased when the synthesizer is not rack mounted by using the front panel handles. The Rack Mount and Handle Kit part number is 5062-3983.

Option 1CR - Rack Slide Kit This kit is useful when the synthesizer is rack mounted. Access to internal circuits and components or the rear panel is possible without removing the synthesizer from the rack. The Rack Slide Kit part number is 1494-0059. If a non-HP rack enclosure is used, rack adapters can be ordered to allow the slide kit to be used with the non-HP rack. The part number for metric rack adapters is 1494-0023 and the part number for standard inch rack adapters is 1494-0061.

Options

Warranty Options

There are two warranty options available for the synthesizer. These options are as follows:

Option W30 - Two
Additional Years
Return-to-HP Service

This option extends the benefits of factory warranty to provide a total of 3 years of customer return repair service.

Option W32 - Three Year
Return-to-HP Calibration
Service

This option provides 3 years of HP calibration service at HP customer service centers.

Documentation Options

There are two documentation options available for the synthesizer. If the documentation was not ordered with the original shipment and is now desired, it can be ordered from the nearest Hewlett-Packard office using the part numbers included in each of the following paragraphs.

These options are as follows:

Option OB0 - Delete
Operating Documentation

If Option OB0 is ordered, the shipment deletes copies of the *HP 83711A/12A and HP 83711B/12B Synthesized CW Generators User's Guide*, the *HP 83711A/12A and HP 83711B/12B Synthesized CW Generators Programming Guide*, the *HP 83711A/12A and HP 83711B/12B Synthesized CW Generators Quick Start Guide*, and the *HP 83711A/12A, HP 83711B/12B, HP 83731A/32A, and HP 83731B/32B Synthesized CW Generators Calibration Guide*.

- Option OB1 - Extra
Operating Documentation
- If Option OB1 is ordered, the shipment includes an extra copy of the *HP 83711A/12A and HP 83711B/12B Synthesized CW Generators User's Guide*, the *HP 83711A/12A and HP 83711B/12B Synthesized CW Generators Programming Guide*, *HP 83711A/12A and HP 83711B/12B Synthesized CW Generators Quick Start Guide*, and the *HP 83711A/12A, HP 83711B/12B, HP 83731A/32A, and HP 83731B/32B Synthesized CW Generators Calibration Guide*.
- Option OBV -
Component-Level
Information Packet (CLIP)
- If Option OBV is ordered, the shipment includes a copy of the *HP 83711A/12A, HP 83711B/12B, HP 83731A/32A, and HP 83731B/32B Synthesized CW Generators Component-Level Information Packet*.
- Option OBW - Service
Documentation
- If Option OBW is ordered, the shipment includes a copy of the *HP 83711A/12A and HP 83711B/12B Synthesized CW Generators Service Guide*.
- Option OBX -
Component-Level
Information Packet
(CLIP)/Service
Documentation
- If Option OBX is ordered, the shipment includes a copy of the *HP 83711A/12A, HP 83711B/12B, HP 83731A/32A, and HP 83731B/32B Synthesized CW Generators Component-Level Information Packet* and a copy of the *HP 83711A/12A and 83711B/12B Synthesized CW Generators Service Guide*.

Specifications and Options

 Front/Rear Panel

Front/Rear Panel

This chapter contains detailed information on various aspects of the synthesizer front and rear panel. Information on the synthesizer display, front panel connectors, power cable, etc., can be found in this chapter.

Annunciators

The HP 83711A/12A and 83711B/12B front panel display contains annunciators that show the status of several of the synthesizer functions and settings.

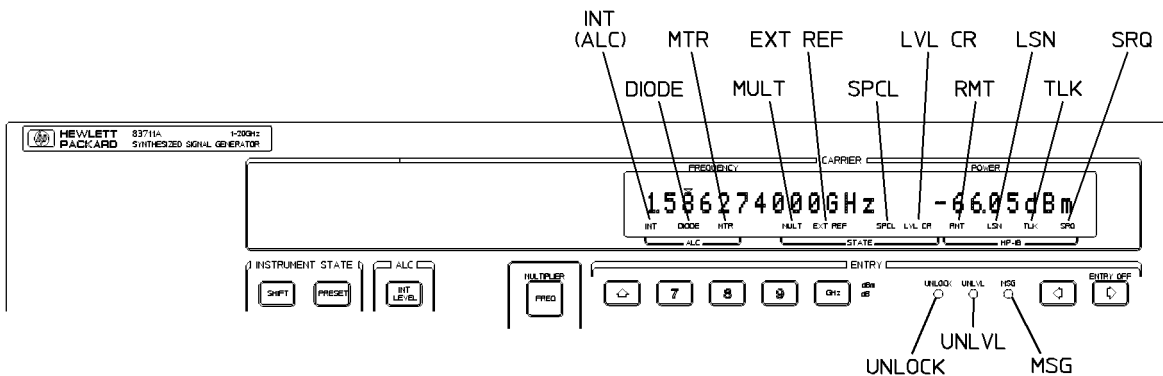

Figure 5-1. Synthesizer Display Annunciators

All annunciators except the UNLOCK, UNLVL, and MSG annunciators are contained on the fluorescent display. A description of each of the annunciators follows.

- INT (ALC) This annunciator indicates that internal power leveling is selected.
- DIODE (ALC) This annunciator indicates that external diode power leveling is selected.
- MTR (ALC) This annunciator indicates that external power meter leveling is selected.
- MULT This annunciator indicates that the frequency multiplier function is active.
- EXT REF This annunciator indicates that an external time base is currently being used.

Annunciators

SPCL	This annunciator indicates that one or more special functions are enabled.
LVL CR	This annunciator indicates that the synthesizer output is currently being leveled using stored level correction data.
RMT	This annunciator indicates that the instrument is in the HP-IB remote state, that is, the instrument is under control of an external HP-IB controller.
LSN	This annunciator indicates that the instrument is addressed to listen (accept data or commands).
TLK	This annunciator indicates that the instrument is addressed to talk (output data).
SRQ	This annunciator indicates that the instrument is generating a service request to the external controller.
UNLOCK	This LED annunciator indicates that one or more of the synthesizer frequency control circuits is not phase locked.
UNLVL	This LED annunciator indicates that the synthesizer output power is unleveled. When the UNLVL annunciator is lit, the power level shown in the display might be incorrect.
MSG	This LED annunciator indicates that uncleared error messages are in the synthesizer front panel error queue.

See Also

Connectors

Display

EXT DIODE

EXT METER

INT LEVEL

MSG

MULTIPLIER

SPCL

Connectors

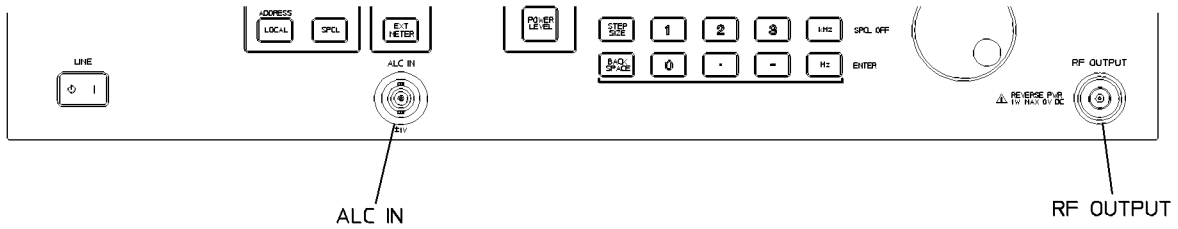

Figure 5-2. Synthesizer Connectors - Front Panel

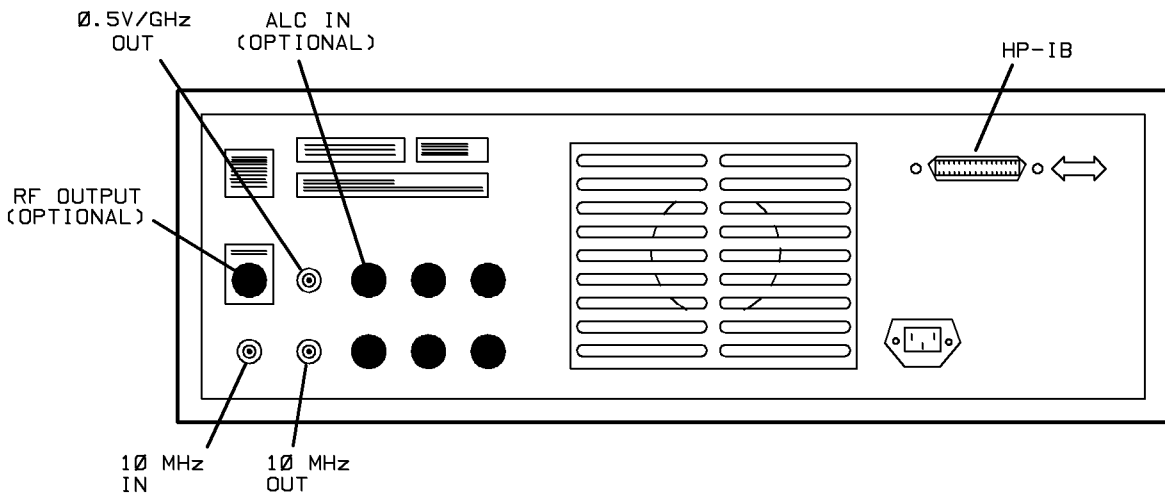

Figure 5-3. Synthesizer Connectors - Rear Panel

Coaxial Connectors

- 0.5 V/GHz OUT** This rear panel BNC connector can be used as one of the inputs to a recorder. It produces a DC voltage output that varies linearly with the frequency currently at the RF OUTPUT connector. For example, if the current frequency setting is 5.5 GHz, the voltage at this connector would be 2.75 V. The nominal source impedance is $\leq 250\Omega$.
- 10 MHz IN** This rear panel BNC connector accepts a 10 MHz, 0 to +10 dBm reference signal for operation referenced to an external time base. The nominal input impedance of this input is 50Ω . This connector detects when a valid reference signal is connected to it and automatically switches from internal to external reference operation.
- 10 MHz OUT** This rear panel BNC connector provides a 3 dBm ± 3 dB, 10 MHz signal derived from the internal frequency standard of the synthesizer. The nominal source impedance is 50Ω .
- ALC IN** This front panel BNC connector allows the synthesizer to be externally leveled. It is used with external power meter leveling or external diode leveling. The leveling signal at this input must be in the ± 1 V range. The nominal input impedance is $150\text{ k}\Omega$. The damage level is $\geq +12$ V or ≤ -12 V.
- RF OUTPUT** The standard front panel RF OUTPUT connector is a Type-N precision connector. When Option 1E9 is installed, this front panel connector is a 3.5 mm precision connector. The nominal source impedance is 50Ω .
- When making connections to this connector, carefully align the center conductor elements, then rotate the knurled barrel while mating components remain still. Tighten the barrel until firm contact is made.
- Take care when working with this connector. If the connector is mechanically degraded in any way, high frequency losses can occur. Refer to application note 326, *Coaxial Systems - Principles of Microwave Connector Care* (HP part number 5954-1566) for more information.

Connectors

HP-IB Connector

This connector allows the synthesizer to be connected to other instruments or devices on the interface bus. Details of this cable are shown in Figure 5-4. HP part numbers for various HP-IB cables that are available are shown in the table following the figure.

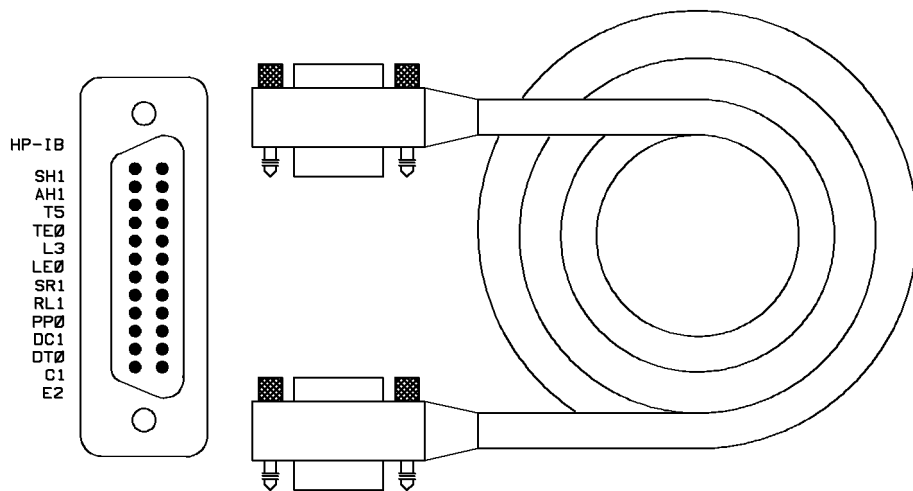

Figure 5-4. HP-IB Connector and Cable

Table 5-1. HP-IB Interface Cables Available

HP-IB Cable Part Number	Length
HP 10833A	1 m 3.3 ft
HP 10833B	2 m 6.6 ft
HP 10833C	4 m 13.2 ft
HP 10833D	0.5 m 1.6 ft

As many as 14 HP-IB instruments can be connected to the synthesizer (15 total instruments in the system). The cables can be interconnected in a star pattern (one central instrument with the HP-IB cables emanating from that instrument like spokes on a wheel), or in a linear pattern (like boxcars on a train), or a combination of the two. There are certain restrictions that must be followed when interconnecting instruments. These restrictions are as follows:

- Each instrument must have a unique HP-IB address, ranging from 0 to 30 (decimal). Refer to “To Set the HP-IB Address” in Chapter 2 for information on setting the synthesizer HP-IB address.
- In a two-instrument system that uses just one HP-IB cable, the cable length must not exceed 4 meters (13.2 ft).
- When more than two instruments are connected on the bus, the cable length to each instrument must not exceed two meters (6.6 ft).
- The total cable length between all instruments must not exceed 20 meters (65 ft).

Hewlett-Packard manufactures HP-IB extender instruments (Models HP 37201A and HP 37204A/B) that overcome the range limitations imposed by the cabling rules. These extenders allow twin pair cable operation up to 1 km (3,280 ft), and telephone modem operation over any distance. HP sales and service offices can provide additional information on the HP-IB extenders.

Connectors

The codes in the following list describe the HP-IB interface capabilities of the synthesizer using IEEE Std.488.1 compatibility codes (HP-IB, GP-IB, IEEE-488, and IEC-625 are all electrically equivalent). Briefly, the mnemonics translate as follows:

SH1	Source Handshake, complete capability.
AH1	Acceptor Handshake, complete capability.
T5	Talker; capable of basic talker, serial poll, and unaddress if MLA.
TE0	Talker, Extended address; no capability.
L3	Listener; capable of basic listener and unaddress if MTA.
LE0	Listener, Extended address; no capability.
SR1	Service Request, complete capability.
RL1	Remote Local, complete capability.
PP0	Parallel Poll, no capability.
DC1	Device Clear, complete capability.
DT0	Device Trigger, no capability.
C1	Controller capability, system controller.
E2	Electrical specification indicating tri-state outputs.

These codes are described completely in the IEEE Standard 488 (1978), *IEEE Standard Digital Interface for Programmable Instrumentation* or the identical ANSI Standard MC1.1.

Display

The HP 83711A/12A and 83711B/12B front panel display contains an area for displaying the current operating parameters of the synthesizer. Front panel annunciators show the status of several of the synthesizer functions and settings.

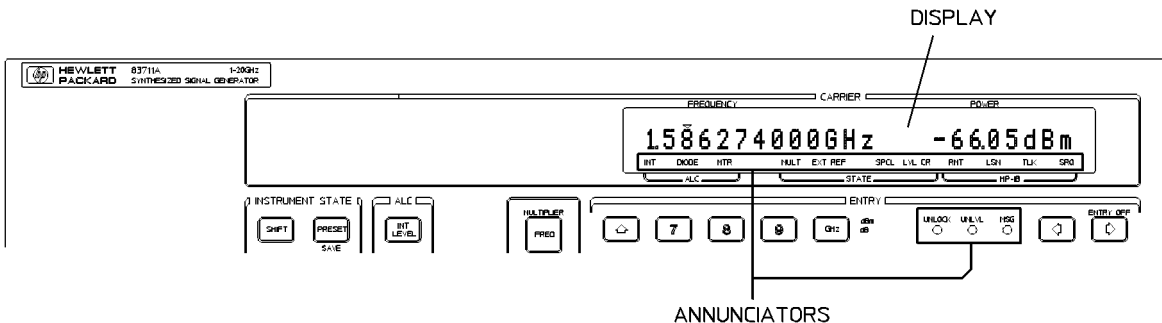

Figure 5-5. Synthesizer Display

A description of the display follows:

Annunciators The front panel annunciators show the status of several of the synthesizer functions and settings. *An annunciator that is in fluorescent display is not visible if its associated function is not active or selected.* For example, if diode detector leveling is currently selected, the **DIODE** annunciator will be lit, otherwise, it will not be visible. The fluorescent display annunciators are **INT** (ALC), **DIODE** (ALC), **MTR** (ALC), **MULT**, **EXT REF**, **SPCL**, **LVL CR**, **RMT**, **LSN**, **TLK**, and **SRQ**.

The three front panel LED annunciators (**UNLOCK**, **UNLVL**, and **MSG**) will be lit to warn you that an associated condition exists. (For example, if error messages are in the error queue, the **MSG** annunciator will be lit.) An

Display

explanation of each annunciator can be found in the “Annunciators” entry in this section of the manual.

Display

The carrier display is the fluorescent display that is on the right side of the front panel. The primary purpose of this display is to indicate the current setting of the synthesizer output frequency and power level. When parameter entry is initiated, the information in this display will be temporarily replaced with a parameter entry display. Pressing **(Hz)** (ENTER) returns the frequency and power level information to the display. As an example, if the **(RECALL)** key is pressed, the text `RECALL STATE FROM REG 0` appears in the display. If a cursor (▼) appears over one of the digits in the display, this digit will be increased or decreased as the knob is rotated. Note that the cursor indicates that particular parameter is active. The cursor can be moved left or right by pressing the **(←)** or **(→)** keys.

NOTE

When operating the synthesizer in a secure environment, the display can be blanked so that the synthesizer parameters and status cannot be viewed. For more information, refer to the “Clear Display” entry in Chapter 7 of this manual.

See Also

Annunciators

CLEAR DISPLAY

DISPlay[:WINDow][:STATe]

Knob

Knob

The knob is used to increase or decrease parameter values. A cursor (▼) over a digit in the display indicates that digit will be increased or decreased in steps of one as the knob is rotated.

Clockwise rotation of the knob increases the display digit under the cursor and counterclockwise rotation decreases it. Pressing the (←) key moves the display cursor to the left and pressing the (→) key moves the cursor to the right. As the knob is rotated, the display will carry over to the adjacent digit. For example, if the display reads 9.000000000 GHz with the cursor over the “9” digit, clockwise rotation of the knob will cause the displayed frequency to change to 10.000000000 GHz. The cursor will remain over the first digit before the decimal point (the “0” in “10”).

If (SHIFT) (ENTRY OFF), (⇒) has been enabled, the cursor will disappear from the display and rotating the knob will have no affect on the synthesizer parameters.

Equivalent SCPI Command

There is no equivalent SCPI command for knob rotation, however, the “SYST:KEY 61” command simulates clockwise knob rotation and the “SYST:KEY 62” command simulates counterclockwise knob rotation.

Knob

See Also



ENTRY OFF
SYSTem:KEY

POWER Switch

The POWER switch (LINE on HP 83711A/B) turns power to the synthesizer to either on (I) or standby (⏻).

The POWER switch (LINE on HP 83711A/B) is located at the bottom left corner of the front panel and is a rocker-type switch. Pressing the I symbol turns the synthesizer on and pressing the ⏻ symbol turns it to standby. When set to standby, most of the synthesizer circuitry is powered off, however, power to the internal timebase is not disconnected.

WARNING

Before turning the synthesizer on, make sure that it is grounded through the protective conductor of the power cable to a mains power receptacle provided with protective earth contact. Any interruption of the protective grounding conductor inside or outside of the synthesizer or disconnection of the protective earth terminal can result in personal injury.

CAUTION

Before turning the synthesizer on, set the line voltage selector to the voltage of the power source. Failure to do this can cause instrument damage when the power cable is plugged in. For information on setting the line voltage selector, refer to “To Install the Synthesizer” in Chapter 1 of this manual.

See Also

To Install the Synthesizer
Power Cables

Power Cables

The line power cable is supplied in one of several configurations, depending on the destination of the original shipment.

Each instrument is equipped with a three-wire power cable. When connected to an appropriate AC power receptacle, this cable grounds the instrument chassis. The type of power cable shipped with each instrument depends on the country of destination. See Figure 5-6, "Power Cable and Line (Mains) Plug Part Numbers," for the part numbers of these power cables. Cables are available in different lengths and some with right-angle plugs to the instrument. Check with your nearest Hewlett-Packard service center for descriptions and part numbers for these cables.

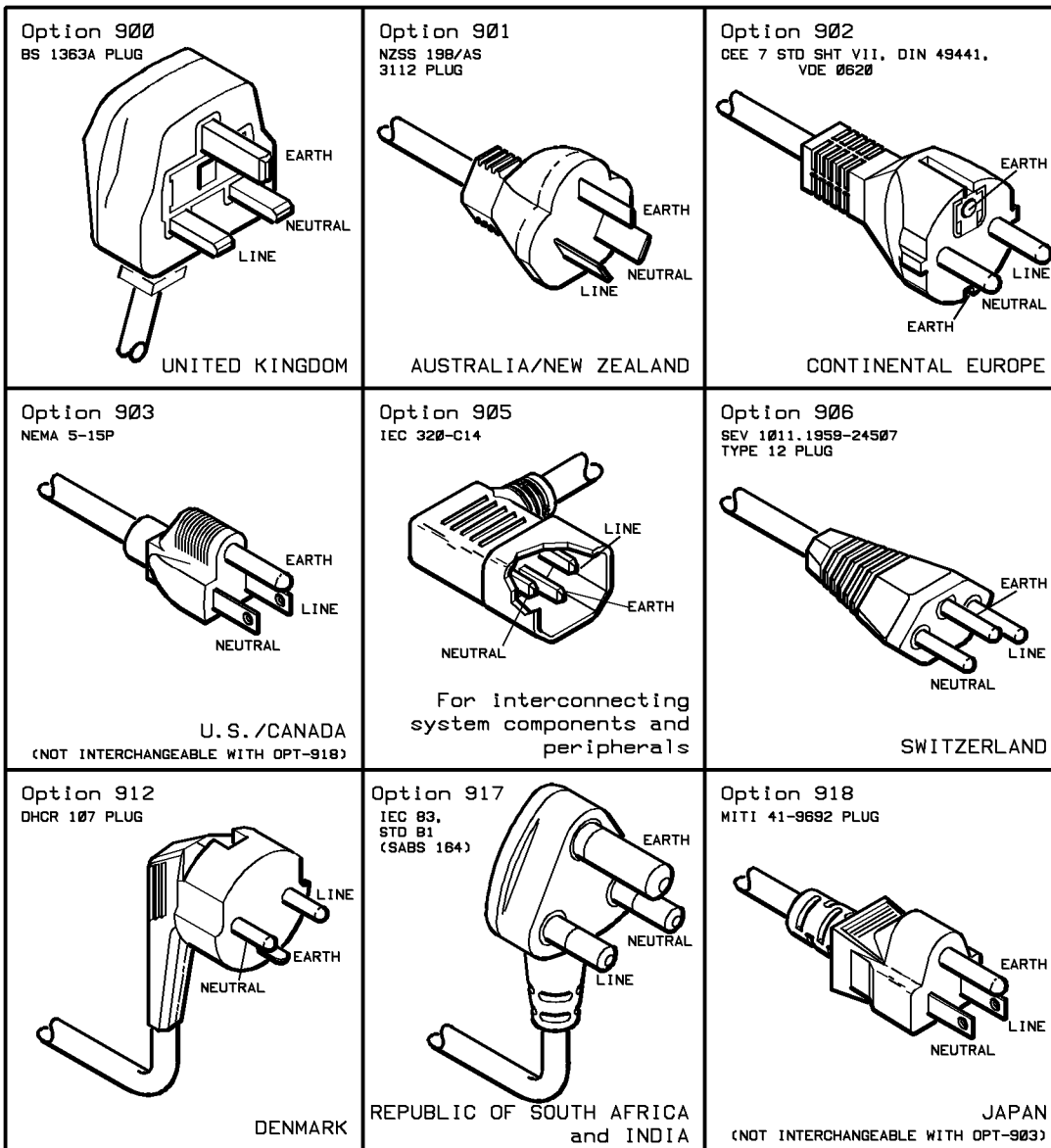

Figure 5-6. Power Cable and Line (Mains) Plug Part Numbers

Front/Rear Panel





Keys/Shifted Functions

Keys/Shifted Functions



This chapter contains detailed information on the various keys and shifted functions found on the synthesizer front panel. Key names are printed on the keycap and represent the primary function of the key. The shifted function names appear above certain keys on the synthesizer front panel. Shifted functions are always accessed by pressing the **(SHIFT)** key and then the key below the shifted function name. If no text appears above a given key, that key has no shifted function associated with it.



⇒

The  key moves the cursor (▼) that appears over one of the digits in the display to the right one digit each time it is pressed.

The digit that is currently under the cursor will be increased or decreased in steps of one as the knob is rotated. Clockwise rotation of the knob increases the digit under the cursor and counterclockwise rotation decreases it. If pressing the  key moves the cursor too far to the right, pressing the  key will move the cursor back to the left.

NOTE



The digit under the cursor is affected only by the knob, not the  and  keys.

If  (ENTRY OFF),  has been enabled, the cursor will disappear from the display and rotating the knob will have no effect on the parameter. Note that the cursor indicates that particular parameter is active. For example, if the cursor appears over any digit in the frequency display, the frequency parameter is the active parameter.

If an arrow key is pressed that moves the cursor to a position that is off the display, another cursor will appear next to the original cursor to indicate that the actual cursor position is off the display. For example, if a frequency multiplier of six is entered into the synthesizer, the maximum frequency entry that can be made is 120 GHz (20 GHz×6). The display, however, only has room to display two digits to the left of the decimal point. If you were to attempt to position the cursor three digits to the left of the decimal point, the double cursor would appear, indicating that the actual cursor position is off the display.

⇒

Equivalent SCPI Command

There is no equivalent SCPI command for the  key, however, sending the “SYST:KEY 45” command is effectively the same as pressing the  key.

See Also







ENTRY OFF

Knob



SYSTem:KEY





The  key moves the cursor () that appears over one of the digits in the display to the left one digit each time it is pressed.

The digit that is currently under the cursor will be increased or decreased in steps of one as the knob is rotated. Clockwise rotation of the knob increases the digit under the cursor and counterclockwise rotation decreases it. If pressing the  key moves the cursor too far to the left, pressing the  key will move the cursor back to the right.

NOTE



The digit under the cursor is affected only by the knob, not the  and  keys.

If ,  (ENTRY OFF) has been enabled, the cursor will disappear from the display and rotating the knob will have no effect on the parameter. Note that the cursor indicates that particular parameter is active. For example, if the cursor appears over any digit in the frequency display, the frequency parameter is the active parameter.

If an arrow key is pressed that moves the cursor to a position that is off the display, another cursor will appear next to the original cursor to indicate that the actual cursor position is off the display. For example, if a frequency multiplier of six is entered into the synthesizer, the maximum frequency entry that can be made is 120 GHz (20 GHz×6). The display, however, only has room to display two digits to the left of the decimal point. If you were to attempt to position the cursor three digits to the left of the decimal point, the double cursor would appear, indicating that the actual cursor position is off the display.



Equivalent SCPI Command

There is no equivalent SCPI command for the  key, however, sending the “SYST:KEY 37” command is effectively the same as pressing the  key.

See Also









ENTRY OFF

Knob

SYSTem:KEY





The  key allows you to incrementally add to the current value of a parameter.

Pressing the  key will increase the currently active parameter by the increment value set with the  key. A parameter can be made active by pressing its associated function key. For example, pressing the  key will make frequency the active parameter, pressing the  key will make output power level the active parameter, etc. If no parameter is currently active, or the ,  (ENTRY OFF) function has been enabled, pressing the  key will have no effect.

If the  key is pressed and held down, the key will auto-repeat, that is, the active parameter will automatically increase rapidly in increment value steps.

Equivalent SCPI Commands

There is no equivalent SCPI command for the  key, however, the various SCPI commands that send numeric parameter data include an “UP” parameter option. Sending the “UP” parameter in place of the numeric parameter is effectively the same as pressing the  key. For example, if you want to increase the output frequency by its current increment value, send the following command:

```
OUTPUT 719; "FREQ UP"
```



See Also



ENTRY OFF

STEP SIZE



The key allows you to incrementally subtract from the current value of a parameter.

Pressing the key will decrease the currently active parameter by the increment value set with the key. A parameter can be made active by pressing its associated function key. For example, pressing the key will make frequency the active parameter, pressing the key will make output power level the active parameter, etc. If no parameter is currently active, or the , (ENTRY OFF) function has been enabled, pressing the key will have no effect.

If the key is pressed and held down, the key will auto-repeat, that is, the active parameter will automatically decrease rapidly in increment value steps.

Equivalent SCPI Commands

There is no equivalent SCPI command for the key, however, the various SCPI commands that send numeric parameter data include a “DOWN” parameter option. Sending the “DOWN” parameter in place of the numeric parameter is effectively the same as pressing the key. For example, if you want to decrease the output frequency by its current increment value, send the following command:

```
OUTPUT 719; "FREQ DOWN"
```

Keys/Shifted Functions



See Also



ENTRY OFF

STEP SIZE

ADDRESS

Invoking the ADDRESS function (pressing the **SHIFT** key and then the **LOCAL** key) displays and allows you to change the synthesizer HP-IB address.

When **SHIFT**, **LOCAL** is pressed, the current HP-IB address will be displayed across the display in the following format:

HP-IB ADDRESS **

where ** is the current HP-IB address. The range for valid addresses is 00 to 30. The HP-IB address is preset at the factory to 19. Pressing the **PRESET** key has no effect on the HP-IB address. The preset up/down arrow increment value is 1.

Equivalent SCPI Command

`SYST:COMM:GPIB:ADDR address` *sets the synthesizer HP-IB address as defined by the “address” parameter.*

See Also

SYSTEM:COMMunicate:GPIB:ADDRESS

BACK SPACE

The **BACK SPACE** key allows you to cancel part or all of a parameter during entry.

The **BACK SPACE** key has an effect on the display only after a function key (**FREQ**, **POWER LEVEL**, etc.) is pressed and before the entry is terminated. If **BACK SPACE** is pressed repeatedly so that the whole parameter is canceled, the display reverts back to what it was before the function key was pressed.

Equivalent SCPI Command

There is no equivalent SCPI command for the **BACK SPACE** key, however, sending the “SYST:KEY 54” command is effectively the same as pressing the **BACK SPACE** key.

See Also

SYSTem:KEY

ENTER (Hz)

The ENTER key (actually the secondary function of the **Hz** key) is used to terminate unitless parameter entries. It can also be used to return the display to its default state.

The **Hz** (ENTER) key is used to terminate unitless parameter entries. The unitless parameters are multiplier values, special function numbers, instrument state register numbers, level correction register numbers, and the synthesizer and power meter HP-IB addresses.

The ENTER key can also be used to return the display to its default state. When the display is in the default state, the display shows frequency and power level. In the display default state, no parameters are active. To use the ENTER key to return the display to the default state, press the ENTER key without first pressing a numeric key (that is, the keys numbered 0 through 9). For example, if a multiplier value of 5 is entered, the display will continue to show `FREQUENCY MULTIPLIER 5` after the entry is terminated with the cursor (▼) over the 5. Pressing ENTER again will return the display to the default state mentioned above.

Equivalent SCPI Command

There is no equivalent SCPI command for the ENTER key, however, sending the “SYST:KEY 58” command is effectively the same as pressing the ENTER key.

See Also

ADDRESS
MULTIPLIER
PWR MTR ADDRS
RCL CR
RECALL
SAVE
SAVE CR
SPCL
SYSTem:KEY

ENTRY OFF

Invoking the ENTRY OFF function (pressing the **SHIFT** key and then the **⇒** key) disables the parameter entry/modification keys. The parameter entry/modification keys include the numeric keypad as well as the **↑**, **↓**, **STEP SIZE**, **←**, and **⇒** keys and the knob.

Once the ENTRY OFF function has been enabled, it will be cancelled as soon as one of the function keys (**FREQ**, **POWER LEVEL** etc.) is pressed.

Equivalent SCPI Command

There is no equivalent SCPI command for the ENTRY OFF function, however, sending the “SYST:KEY 0;KEY 45” command is effectively the same as pressing **SHIFT**, **⇒**.

See Also

SYSTem:KEY

EXT DIODE

The **EXT DIODE** key enables external diode leveling. External diode leveling is a method of automatic level control (ALC) of the output signal using an external diode detector.

When the **EXT DIODE** key is pressed, the DIODE annunciator will be lit. If the procedure, “To Use External Diode Detector Leveling” in Chapter 3 has been followed correctly, the synthesizer RF output will be externally leveled via the diode detector feedback loop.

External Diode Detector Leveling

The purpose of a leveling circuit is to provide constant power, independent of the load, and minimize power variations versus frequency.

External diode detector leveling is used in applications where it is desired to level the power at some point outside the synthesizer with an external diode detector. When frequency dependent losses are involved, the RF output power at the end of the signal path will not have a constant amplitude over the synthesizer frequency range. For example, if a cable is used at the output of the synthesizer that has a constant 0.5 dB/GHz loss, 5 dB of attenuation at the output of the cable occurs after a 10 GHz frequency increase, even though the power at the input to the cable is constant. By externally leveling power at the output of the cable, the synthesizer would increase power at the input of the cable to produce a constant power level at the output of the cable.

External diode detector leveling requires that external equipment be connected to the synthesizer, as shown in Figure 6-1.

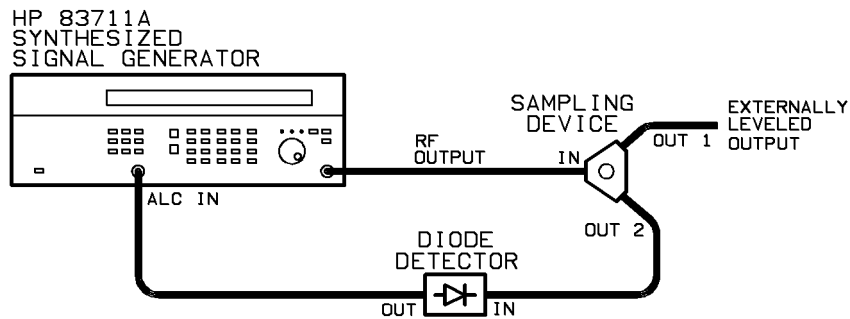

Figure 6-1. External Diode Detector Leveling Setup

When external diode detector leveling is chosen, power is sampled at the external sampling device (either a directional coupler or power splitter) by an external diode detector that is typically operating in the square law region. When the diode detector is operating in the square law region, it will provide a DC voltage that is proportional to the power sampled at the input to the detector. This DC voltage is fed back to the synthesizer via the ALC IN connector. The synthesizer then adjusts its output power level to maintain a constant power level at the input to the external diode detector.

Applications

External leveling can be used when your application requires long cables that will cause frequency-dependent losses. It also enables devices, such as amplifiers, mixers, etc. to be inserted into the RF signal path so that the output of the inserted device is controlled by the synthesizer.

Advantages of Diode Detector Leveling

When diode detector leveling is used, power level correction is continuous.

External diode detector leveling has the advantage of faster settling time than power meter leveling. The settling time is variable and is dependent on the devices in the external leveling loop.

Disadvantages of Diode Detector Leveling

The diode detector must be capable of producing between 1 mV and 1 V of ALC voltage for the power level at the sampling point. This typically restricts the lower limit at which external diode detector leveling will function.

Diode detector leveling might not provide an accurate power display on the synthesizer if the diode detector is operating outside of the square law region. Diode detector leveling also does not provide temperature compensation. Power level recalibration might be required in environments that are not temperature stabilized.

External diode detector leveling requires that external equipment be connected to the synthesizer.

NOTE

Before selecting **EXT DIODE**, you should adjust the synthesizer power level using internal leveling so that the step attenuator is set to the correct setting.

Equivalent SCPI Command

`POW:ALC:SOUR DIOD` *enables external diode detector leveling.*

See Also

[EXT METER](#)

[INT LEVEL](#)

`[SOURce[1]:]POWer:ALC:SOURce`

To Use External Diode Detector Leveling

To Use the Level Correct Routine

EXT METER

The **EXT METER** key enables external power meter leveling. External power meter leveling is a method of automatic level control (ALC) of the output signal using an external power meter and power sensor.

When the **EXT METER** key is pressed, you are prompted to put the power meter in the range hold mode and then enter the power meter reading into the synthesizer. After the range hold power meter value is entered, the **MTR** annunciator will be lit. If the procedure, “To Use External Power Meter Leveling” in Chapter 3 has been followed correctly, the RF output will be externally leveled via the power meter feedback loop.

NOTE

The range hold power meter reading is the power level that is used by the synthesizer to calibrate the recorder output voltage of the power meter versus the synthesizer output power.

External Power Meter Leveling

The purpose of a leveling circuit is to provide constant power, independent of the load, and minimize power variations versus frequency.

External power meter leveling is used in applications where it is desired to level the power at some point outside the synthesizer with an external power meter. When frequency dependent losses are involved, the RF output power at the end of the signal path will not have a constant amplitude over the synthesizer frequency range. For example, if a cable is used at the output of the synthesizer that has a constant 0.5 dB/GHz loss, 5 dB of attenuation at

the output of the cable occurs after a 10 GHz frequency increase, even though the power at the input to the cable is constant. By externally leveling power at the output of the cable, the synthesizer would increase power at the input of the cable to produce a constant power level at the output of the cable.

External power meter leveling requires that external equipment be connected to the synthesizer, as shown in Figure 6-2.

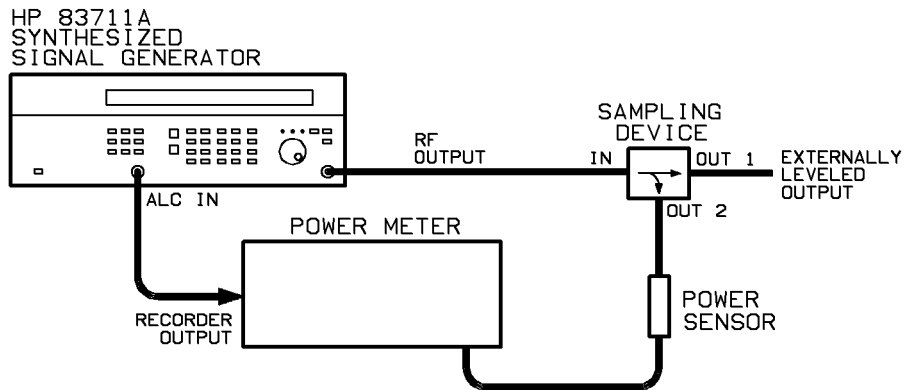

Figure 6-2. External Power Meter Leveling Setup

When external power meter leveling is chosen, power is sampled at the external sampling device (either a directional coupler or power splitter) by the external power sensor. An automatic level control voltage is then generated by the external power meter and fed back to the synthesizer via the ALC IN connector. The synthesizer then adjusts its output power level to maintain a constant power level at the input of the external power sensor.

EXT METER

Applications

External leveling can be used when your application requires long cables that will cause frequency-dependent losses. It also enables devices, such as amplifiers, mixers, etc. to be inserted into the RF signal path so that the output of the inserted device is controlled by the synthesizer.

External Equipment Limitations

Power Meter

The power meter must be capable of producing a 0 V to 1 V output voltage linearly proportional to power over each decade of range. The recorder output of most power meters provides this voltage.

Power Sensor

The power sensor must have a frequency range that is appropriate for the range of frequencies being leveled. The sensor must also have enough dynamic range to measure the level at the output of the directional coupler or power splitter. As an example, to level signals in the -7 dBm to 0 dBm range using a 10 dB coupler, the power sensor must be capable of measuring power in the -17 to -10 dBm range.

Advantages of Power Meter Leveling

When power meter leveling is used, power level correction is continuous.

External power meter leveling has the advantages of better accuracy and temperature stability, and improved vernier linearity over external diode detector leveling. Using a sensitive power sensor allows ALC at levels as low as the power meter and sensor can measure.

Disadvantages of Power Meter Leveling

One disadvantage of power meter leveling is a longer settling time than diode detector or internal leveling. The settling time is dependent on the power range and sensor used. The synthesizer assumes a settling time of two seconds to allow the sensor to reach the correct power level.

Depending on the power sensor and range being used, the power meter might or might not have finished settling. Power is typically settled within two seconds for the two highest ranges of the power meter.

External power meter leveling requires that external equipment be connected to the synthesizer.

NOTE

Before selecting **(EXT METER)**, you should adjust the power level using internal leveling so that the step attenuator is set to the correct setting.

EXT METER

Equivalent SCPI Commands

NOTE

The following is only the command that selects external power meter leveling. External power meter leveling, however, is a multi-step process that involves issuing several commands.

`POW:ALC:PMET pmeter` *sets the power meter range hold value as defined by the “pmeter” parameter.*

`POW:ALC:SOUR PMET` *sets the alc source to power meter.*

See Also

`EXT DIODE`

`INT LEVEL`

`[SOURce[1]:]POWer:ALC:PMETer`

`[SOURce[1]:]POWer:ALC:SOURce`

To Use External Power Meter Leveling

FREQ

The **FREQ** (frequency) key allows you to set the output frequency of the synthesizer.

Frequency is displayed in the left portion of the display. The preset value is 3 GHz.

The valid output frequency range differs depending on the synthesizer model:

HP 83711A/11B - 1.0 GHz to 20.0 GHz

HP 83712A/12B - 0.01 GHz to 20.0 GHz

If a frequency entry is made that is outside the allowable range, an error message will be generated and the actual frequency will be set to either its upper or lower limit (whichever is closest to the input frequency). Standard frequency resolution is 1 kHz over the range of 0.01 GHz to 20 GHz.

NOTE

When Option 1E8 is installed, frequency resolution is 1 Hz over the entire frequency range.

The preset up/down arrow increment value is 100 MHz. The increment value will be rounded to the nearest 1 kHz.

FREQ

Notes

1. When Option 1E8 is installed in either the HP 83711A/12A or HP 83711B/12B, increment values with 1 Hz resolution are accepted over the entire frequency range.
2. If the Multiplier function is being used, the frequency displayed is the frequency at the output of the multiplier, not the output of the synthesizer.

Equivalent SCPI Command

FREQ freq *sets the synthesizer output frequency as defined by the “freq” parameter.*

See Also

MULTIPLIER
[SOURce[1]:]FREQuency[:CW]:FIXed]

INT LEVEL

The **INT LEVEL** key enables internal leveling. Internal leveling uses an internal ALC (automatic level control) detector to provide automatic level control of the output power at the RF OUTPUT connector.

When the **INT LEVEL** key is pressed, the INT (ALC) annunciator will be lit.

Internal leveling is used to control the internal RF signal over a specified range (the vernier range) of -1 to $+13$ dBm. Additional dynamic range is provided by an optional -110 dB step attenuator (Option 1E1) to give an effective dynamic range of -110 to $+8$ dBm (-90 to $+8$ dBm on HP 83711A/12A).

An ALC unlevelled condition occurs when the internal ALC circuitry cannot maintain leveling. This can occur due to an instrument fault or because the instrument is set to level for an RF output level that is beyond its capability. Calibrated output level is only guaranteed when the UNLVL annunciator is not lit.

When the synthesizer UNLVL annunciator lights, the knob, arrow keys, or the numeric keypad can still be used to change displayed power up to the maximum value. However, the actual output power will *not* increase. Only the displayed value changes.

The internal ALC circuit maintains a constant RF power level over frequency at the RF OUTPUT connector. The ALC circuit is a feedback control system where output power is measured and compared to the desired power level. When output power does not equal the desired power level, the ALC changes the output until the actual and desired levels are equal.

The actual maximum leveled power available is dependent upon the frequency and varies across the range of the synthesizer.

The allowable range for power level entries (using the **POWER LEVEL** key) is -15 dBm to $+30$ dBm for standard configuration instruments and -120 dBm (-100 dBm on HP 83711A/12A) to $+30$ dBm if Option 1E1 is installed.

INT LEVEL

NOTE

The actual maximum internally leveled output power for your instrument at a given frequency can be found by increasing the synthesizer output power until the **UNLVL** annunciator lights.

When the synthesizer is set to the preset state, internal leveling is selected over external diode leveling or external power meter leveling.

Advantages of Internal Leveling

Internal leveling is self-contained; it does not require any external equipment as does external diode leveling or external power meter leveling. Leveled power is specified at the **RF OUTPUT** connector.

Disadvantages of Internal Leveling

Internal leveling does not compensate for losses or gains in the output signal path.

Equivalent SCPI Commands

POW:ALC:SOUR INT *enables internal leveling.*

See Also

EXT DIODE

EXT METER

POWER LEVEL

[SOURce[1]:]POWer:ALC

“To Use the Level Correct Routine” in Chapter 3

LOCAL

The **LOCAL** key removes the synthesizer from the remote state.

When the synthesizer is no longer in the remote state, the RMT annunciator in the display will no longer be lit.

If the instrument is in the local lockout (LLO) state, pressing the **LOCAL** key will not remove the instrument from the remote state. In this case, the only way to return the synthesizer to local operation is either by setting the REN bus control line false or sending the instrument the go-to-local (GTL) bus command.

Equivalent SCPI Command

There is no equivalent SCPI command for the **LOCAL** key, however, sending the “SYST:KEY 8” command is effectively the same as pressing the **LOCAL** key.

See Also

Connectors
SYSTem:KEY

LVL CR

The LVL CR (level correct) function allows you to calibrate external path losses in the signal path. The level correct function creates a table in synthesizer memory of external path loss values versus frequency.

Invoking the LVL CR (level correct) function (pressing the **(SHIFT)** key and then the **(INT LEVEL)** key) causes the synthesizer to prompt you for the start frequency, stop frequency, and number of points in the level correction table. Once the start frequency, stop frequency, and number of points are entered, you are given the option of running the level correct routine.

When **(SHIFT)**, **(INT LEVEL)** (LVL CR) is pressed, the synthesizer initially prompts you for the level correct start frequency.

- When **(SHIFT)**, **(INT LEVEL)** (LVL CR) is pressed, the text `COR START XXXGHZ` will be displayed where XXX is the current start frequency.

At this point, a new start frequency can be entered or the existing start frequency can be modified using the knob or arrow keys. The start frequency is used to determine the beginning frequency for the level correction table. The start frequency is the first frequency point in the table.

NOTE

You do not have to choose a new start frequency (or stop frequency or number of points). To keep the same parameter value, press **(Hz)** (ENTER) without entering a new parameter and the next parameter in the sequence will be displayed.

LVL CR

Once you have chosen the proper start frequency, pressing any terminator key while a numeric parameter entry is not in progress will cause the synthesizer to go to stop frequency entry mode.

- When in stop frequency entry mode, the synthesizer will display `COR STOP XXXGHZ`. Stop frequency entry is identical to start frequency entry. The stop frequency is used to determine the ending frequency for the level correction table. The stop frequency is the last frequency point in the table.

Once you have chosen the proper stop frequency, pressing any terminator key while a numeric parameter entry is not in progress will cause the synthesizer to go to number of points entry mode.

- When in number of points entry mode, the synthesizer will display `SET NUMBER OF POINTS XXX`. The number of points value determines how many frequency points will be in the level correct table. The number of points includes the start and stop frequency points. The synthesizer uses the start and stop frequency values and number of points and places evenly spaced frequency points in the level correction table. Note that if the calculated frequency points are not within the synthesizer frequency resolution, they will be rounded.

Once you have chosen the proper number of points, pressing any terminator key while a numeric parameter entry is not in progress will cause the synthesizer to ask if you want to run the level correction routine.

- When the synthesizer is asking if you want to run the level correction routine, the display indicates `RUN CORRECTION?`, `HIT ENTER`. If you press the (ENTER) key, the synthesizer begins collecting new level correction data.

For each frequency point in the table, the synthesizer sends the power meter the frequency, waits for the meter to settle, and then reads the power value from the power meter. As the correction runs, the synthesizer calculates the loss data by subtracting the power meter reading from the current power level. (The synthesizer power level is constant during the level correct routine.)

Notes

1. If the level correction routine is aborted (by pressing the **LOCAL** key), the existing level correction data will be unaffected.
2. After the level correction routine has successfully completed, save the level correction data to the level correction table chosen by the "SAVE CR" function. If the routine fails, the entered start and stop frequencies, and number of points will remain at what they were set at. Be aware, however, that the data in the level correct table will still reflect the last successful level correction that was run.

Once the synthesizer has completed the level correct routine and the new level correction table has been generated, it is resident in the synthesizer volatile memory. Pressing **PRESET** will erase the table. The table should be stored in one of four level correction table registers.

The start frequency lower limit is equal to the synthesizer lower frequency limit. The start frequency upper limit is equal to the stop frequency minus the minimum frequency resolution at that frequency. For example, the preset value for start frequency increment value is 100 MHz.

The stop frequency lower limit is equal to the start frequency plus the minimum frequency resolution at that frequency. The stop frequency upper limit is 20 GHz. The preset value for stop frequency increment value is 100 MHz.

The allowable range for number of points is 2 to 401. The preset increment value is 1.

LVL CR

Equivalent SCPI Command

There is no equivalent SCPI command for the LVL CR function, however, the commands under the “Level Correction Commands” tab in Chapter 1 of the *HP 83711A/12A and HP 83711B/12B Synthesized CW Generators Programming Guide* explain how to load data into level correct tables, select tables, turn level correction on, etc.

See Also

LVL CR ON/OFF

PWR MTR ADDRS

RCL CR

SAVE CR

“To Use the Level Correct Routine” in Chapter 3

LVL CR ON/OFF

The LVL CR ON/OFF (level correct on/off) function (**SHIFT**, **POWER LEVEL**) toggles the level correct function on and off.

When the level correct function is on, the LVL COR annunciator is lit and the data in the current level correction table is used to change the power level of the synthesizer. The current level correction table is either the last level correction that was run or the last table recalled from one of the four level correction register locations.

The level correct function compensates for path loss measured during the level correct routine and changes power levels accordingly. Thus, power is flat and leveled over the range of frequency points where data was measured during the routine. For example, assume that the level correction factor at 10 GHz is -4 dB (because there is 4 dB of path loss between the RF OUTPUT connector and the test point). Then, if -10 dBm is desired at 10 GHz (and the level correct function is turned on), the synthesizer actually generates -6 dBm so that the power level at the test point is -10 dBm. Notice that path loss correction is independent of power level.

The preset condition for this function is off.

Notes

1. When level correction is activated and more power is required at the RF OUTPUT than the synthesizer can deliver, an error message is generated and the **UNLVL** annunciator lights. This can occur when the external signal path has loss and the power level is set close to maximum leveled power.
2. If the level correct function is on and an output frequency is requested from the synthesizer that is either greater than the stop frequency or less than the start frequency, *an error message will be generated and the level correction factor for the requested frequency will be zero (no correction).*

LVL CR ON/OFF

Equivalent SCPI Commands

<code>CORR:CSET:SEL</code> <u>FDAT</u> <u>tableno</u>	<i>selects the level correct table as defined by the “tableno” parameter.</i>
<code>CORR:STATe</code> <u>ON OFF</u>	<i>turns user corrections on or off.</i>
<code>CORR:CSET:STAT</code> <u>ON OFF</u>	<i>turns level corrections on or off.</i>

See Also

LVL CR
PWR MTR ADDR5
RCL CR
SAVE CR
[SOURce[1]:]CORRection:CSET[:SElect]
[SOURce[1]:]CORRection:CSET[:STATe]
[SOURce[1]:]CORRection[:STATe]
To Use the Level Correct Routine

MSG

The **MSG** key causes the instrument to display the most recent uncleared error number and a short description of the error to the front panel display.

When uncleared error messages are in the error queue, the front panel **MSG** annunciator will be lit. The **MSG** annunciator will remain lit until all error messages in the queue have been cleared. When an error is read using the **MSG** key, it is cleared as long as the error condition no longer exists.

When the **MSG** key is pressed, the most recent error in the error queue will be displayed. Successive presses of the **MSG** key will display any other errors in the queue. Pressing any function key will remove the error from the display.

When the synthesizer is set to the preset state, the error queue is cleared.

Equivalent SCPI Command

`SYST:ERR?` *returns the oldest uncleared error number and message that is in the error queue.*

See Also

Error Messages
SYSTem:ERRor?

MULTIPLIER

Invoking the MULTIPLIER function (pressing the **(SHIFT)** key and then the **(FREQ)** key) allows you to enter a multiplier value so that the frequency display will indicate the frequency at the output of a frequency multiplier.

NOTE

External equipment is required for frequency multiplication.

When **(SHIFT)**, **(FREQ)** is pressed, the multiplier value will be displayed across the display in the following format:

```
FREQUENCY MULTIPLIER XXX
```

where XXX is the multiplier value. The allowable range for multiplier values is 1 to 100. The preset value is 1 and the preset up/down arrow increment value is 1.

Entering a frequency multiplier value is useful when generating millimeter-wave signals with external multiplier equipment. *The display shows the frequency at the output of the external frequency multiplier, not at the synthesizer RF OUTPUT connector.*

For example, assume a frequency of 30 GHz is required. The synthesizer cannot generate a 30 GHz signal directly, but a frequency doubler can be connected at the RF OUTPUT connector to multiply a 15 GHz signal by two. Setting the multiplier value to two allows you to display the frequency at the output of the multiplier on the synthesizer. Setting the multiplier value to two will display 30 GHz, while the synthesizer is actually generating 15 GHz. Entering a new frequency of 32 GHz will set the synthesizer to 16 GHz.

The minimum resolution at the output of the frequency multiplier is the synthesizer minimum resolution multiplied by the frequency multiplier value. As an example, assume a multiplier value of two has been entered and you attempt to enter a frequency of 30,000,001,000 Hz from the numeric keypad. The synthesizer will try to generate 15,000,000,500 Hz. However, the resolution of this signal (assuming Option 1E8 is not installed) is 500 Hz which is finer than the minimum specified resolution of 1,000 Hz. The actual output frequency would be rounded to 15,000,001,000 Hz and the display would show 30,000,002,000 Hz.

Equivalent SCPI Command

`FREQ:MULT multiplier` *sets the multiplier value as defined by the “multiplier” parameter.*

See Also

FREQ
[SOURce[1]:]FREQuency:MULTiplier
To Generate Millimeter Signals

Numeric Keypad

The numeric keypad is used to enter a value for the current active function. The number is entered (recognized by the synthesizer) when you press the appropriate units terminator key or the **(Hz)** (ENTER) key.

The numeric keypad consists of the numeric keys **(0)** through **(9)**, **(.)**, **(-)**, and the units terminator keys **(GHz)**, **(MHz)**, **(kHz)**, and **(Hz)**. When making an entry, the parameter change will not take effect until a units terminator key is pressed. The **(GHz)** key also functions as the units terminator key for dBm and dB. The **(Hz)** key functions as the terminator key for entries that are unitless (for example, multiplier value entries).

When the numeric keypad is used, data is entered for the active parameter. A cursor (**▼**) will always appear over one of the digits in the active parameter display. If the cursor is absent from the display, the entry hold function is active and the desired function key must be pressed to re-enable the numeric keypad.

The knob and **(↑)**, **(↓)** keys can also be used to change the currently active parameter.

See Also



ENTER

ENTRY OFF

Knob

“To Enter Data with the Numeric Keypad” in Chapter 2

POWER LEVEL

The **POWER LEVEL** key allows you to set the output power level of the synthesizer.

Power level is displayed in the right-hand position of the display.

The allowable range for power level entries is -15 dBm to $+30$ dBm for standard configuration instruments and -120 dBm to $+30$ dBm when Option 1E1 is installed (-100 dBm to $+30$ dBm on HP 83711A/12A).

NOTE

The actual maximum internally leveled output power for your instrument at a given frequency can be found by increasing the synthesizer output power until the **UNLVL** annunciator lights.

Power level resolution is 0.01 dB. The preset power level value is 0 dBm for standard configuration instruments. For instruments with Option 1E1 installed, the preset power level value is -110.00 dBm (-90.0 dBm on HP 83711A/12A). The preset up/down arrow increment value is 1.00 dBm. The minimum increment value is 0.01 dBm.

Three options are available for leveling of the output power. These are internal leveling (**INT LEVEL**), external diode detector leveling (**EXT DIODE**), and external power meter leveling (**EXT METER**). Refer to the respective reference entries in this chapter for information on the different leveling options.

POWER LEVEL

Equivalent SCPI Command

`POW level` *sets the synthesizer output power level as defined by the “level” parameter.*

See Also

`EXT DIODE`

`EXT METER`

`INT LEVEL`

`[SOURce[1]:]POWer[:]LEVel]`

`[SOURce[1]:]POWer:UNIT`

PRESET

The **PRESET** key sets the synthesizer to a known state.

The preset conditions are shown in the following table:

Table 6-1. PRESET Conditions

Parameter	Condition	Parameter	Condition
:CORRection:STAtE	OFF	:POWer:ALC:SOURce	INT
:CORRection:CSET:SElect	FDAT1	:POWer:ALC:PMETer:LEVel	0 dBm
:CORR:CSET:STAtE	OFF	:POWer:ATTenuation:AUTO	ON
:DISPlay:WINDow:STAtE	ON	:POWer:PROTection:STAtE	OFF
:FREQuency:CW	3 GHz	:SYSTem:COMMunicate:GPIB:ADDDress	19 ²
:FREQuency:MULTIplier	1	:SYSTem:COMMunicate:PMETer:ADDDress	13 ²
:MEMory:TABLE:SElect	FDAT1	:SYSTem:LANGuage	"SCPI"
:OUTPut:STAtE	ON	:UNIT:FREQuency	HZ
:OUTPut:PROTection:STAtE	ON	:UNIT:POWer	DBM
:POWer:LEVel	0 dBm ¹	:UNIT:TIME	S

¹ When Option 1E1 is installed, the preset value for power level is -90 dBm for the HP 837311A/12A, and -110 dBm for the HP 83711B/12B.

² Do not change with preset. These are default values when RAM memory is lost.

PRESET

Equivalent SCPI Commands

*RST *sets the synthesizer to a known state.*

or

SYST:PRES

See Also

*RST

SYSTem:PRESet

RCL CR

Invoking the RCL CR (recall level correction table) function (pressing the **(SHIFT)** key and then the **(EXT METER)** key) allows you to recall a previously stored table of level correction data from one of four level correction register locations.

The allowable range for register locations is 1 through 4. When **(SHIFT)**, **(EXT METER)** is pressed, the text RECALL FRM TABLE XXX will be shown on the synthesizer display where XXX is the last level correction register number entered. Once you press a valid numeric key (1 through 4) and terminate the entry by pressing **(Hz)** (**ENTER**), the table of level correction data will be recalled from the location indicated by the numeric key pressed. If level correction data has not been previously stored to a level correction register, an error message is generated and no change to the current data takes place if you attempt to recall a level correction table from that register.

NOTE

The four level correction registers are separate from the instrument state registers. Level correction data is not cleared from memory when the synthesizer is set to the preset state and is unaffected if an instrument state is recalled from one of the instrument state registers.

RCL CR

Equivalent SCPI Command

There is no equivalent SCPI command for the RCL CR function, however, the “SOUR1:CORR:CSET:SEL” command is used to select which level correct table is used to correct power at the synthesizer RF OUTPUT connector.

See Also

LVL CR

LVL CR ON/OFF

SAVE CR

“To Use the Level Correct Routine” in Chapter 3

RECALL

The **RECALL** key allows you to recall a previously stored instrument state from one of ten register locations.

The allowable range for register locations is 0 through 9. When **RECALL** is pressed, the text `RECALL STATE FROM REG XXX` will be shown on the instrument display where `XXX` is the last register number entered. Once you press a valid numeric key (0 through 9) and terminate the entry, the instrument state will be recalled from the location indicated by the numeric key pressed.

If the instrument state has not been previously stored to an instrument state register, the synthesizer will be set to the preset state if you attempt to recall the instrument state from that register.

Equivalent SCPI Command

`*RCL register` *recalls a previously stored instrument state from the register defined by the “register” parameter.*

See Also

PRESET
*RCL
*SAV
SAVE

RF ON/OFF

The **RF ON/OFF** key toggles the signal at the RF OUTPUT connector on and off.

When the RF OUTPUT is turned off, the text OFF will be indicated in the level display in place of dBm.

When the RF output is turned off, the internal oscillators are turned off and the internal RF power shutdown circuit is turned on.

When the synthesizer is set to the preset state, the signal at the RF OUTPUT connector is turned on.

Equivalent SCPI Command

`OUTP:STAT ON|OFF` *turns the signal at the RF Output connector on or off.*

See Also

`OUTPut[:STATe]`

SAVE

Invoking the SAVE function (pressing the **SHIFT** key and then the **RECALL** key) allows you to save the instrument state in one of ten register locations.

The allowable range for register locations is 0 through 9. When **SHIFT**, **RECALL** is pressed, the text SAVE STATE IN REG XXX will be shown on the instrument display where XXX is the last register number entered. Once you press a valid numeric key (0 through 9) and terminate the entry, the instrument state will be saved to the location indicated by the numeric key pressed. Saving the instrument state to a given register location will write over any instrument state previously stored at that location.

All user settings that are affected when the **PRESET** key is pressed will be saved. Level correction tables, however, will not be saved. For information on saving level correction tables, refer to “SAVE CR” in this chapter.

Equivalent SCPI Command

*SAV register *saves the instrument state to the register defined by the “register” parameter.*

See Also

RECALL
*SAV
SAVE CR

SAVE CR

Invoking the SAVE CR (save level correction table) function (pressing the **(SHIFT)** key and then the **(EXT DIODE)** key) allows you to save the current table of level correction data in one of four level correction register locations.

The allowable range for register locations is 1 through 4. When **(SHIFT)**, **(EXT DIODE)** is pressed, the text SAVE IN TABLE XXX will be shown on the synthesizer display where XXX is the last level correction register number entered. Once you press a valid numeric key (1 through 4) and terminate the entry by pressing **(Hz)** (ENTER), the table of level correction data will be saved to the location indicated by the numeric key pressed. Saving the table of level correction data to a given level correction register location will write over any level correction data previously stored at that location.

NOTE

The four level correction registers are separate from the instrument state registers. Level correction data is not cleared from memory when the synthesizer is set to the preset state and is unaffected if an instrument state is recalled from one of the instrument state registers.

Equivalent SCPI Command

There is no equivalent SCPI command for the SAVE CR function, however, the “MEM:TABL:FREQ” and “MEM:TABL:LOSS:MAGN” commands can be used to load frequency and correction factor points into a selected level correct table.

See Also

LVL CR

LVL CR ON/OFF

RCL CR

“To Use the Level Correct Routine” in Chapter 3

SHIFT

The **SHIFT** key causes the alternate function of any key pressed directly after it to be executed.

When the **SHIFT** key is pressed, the word **SHIFT** will be displayed in the display. The next key that is pressed after the **SHIFT** key will execute the function that is indicated by the text that is above the key. As an example, note that **MULTIPLIER** appears directly above the **FREQ** key. **MULTIPLIER** is the alternate function of the **FREQ** key. Pressing **SHIFT**, **FREQ** will enable the frequency multiplier entry mode.

If the **SHIFT** key is pressed prior to pressing a key that has no alternate function, **SHIFT** will be canceled from the display and no action will be taken by the instrument.

If you press the **SHIFT** key accidentally, pressing it again will cancel it without altering synthesizer operation.

Equivalent SCPI Command

There is no equivalent SCPI command for the **SHIFT** key, however, sending the “**SYST:KEY 0**” command is effectively the same as pressing the **SHIFT** key.

See Also

SYSTem:KEY

The **SPCL** key initiates activation of special functions. Once a special function has been activated, it can be turned on or off, or its parameter value can be changed.

When the **SPCL** key is pressed the left-most display shows the last special function used. Press **↑** and **↓** keys to scroll through the list until the desired special function is reached, or press the **SPCL** key and a number on the keyboard between 1 to 52, that corresponds to the desired special function.

When the desired special function is reached, it can be changed by one of two methods, depending on whether it is an ON/OFF function, or has an associated value.

If the function has only ON and OFF values, it can be changed by pressing the **SPCL ON** and **SPCL OFF** keys, or by pressing the **ENTER** key and using the **↑** and **↓** keys.

If the function has an associated parameter, the parameter can be modified by first pressing **ENTER**, and then adjusting the parameter by using either the **↑** and **↓** keys, the RPG, or by entering a value from the keyboard. When entering from the keyboard, the parameter entry is terminated the same way as any parameter entry.

When the synthesizer is set to the preset state, the currently active special function is set to 1 (SHOW INFO).

Equivalent SCPI Command

There is no equivalent SCPI command for the **SPCL** key, however, sending the “SYST:KEY 9” command is effectively the same as pressing the **SPCL** key.

SPCL OFF (kHz)

The SPCL OFF key (actually the secondary function of the **kHz** key) is used to turn on/off-type special functions off.

The **kHz** (SPCL OFF) key is used to turn on/off-type special functions off when they are displayed in the display. The on/off-type special functions are ATTEN HOLD ON/OFF and CLEAR DISPLAY.

The SPCL OFF key will turn the special function off whether it has been selected via the numeric keypad or by using the knob or **↑**, **↓** keys. When the special function has been turned off, the word “OFF” will be shown in the right side of the display and the SPCL annunciator will turn off if no other special functions are selected.

Equivalent SCPI Command

There is no equivalent SCPI command for the SPCL OFF key, however, sending the “SYST:KEY 50” command is effectively the same as pressing the SPCL OFF key.

See Also

ATTEN HOLD ON/OFF

CLEAR DISPLAY

SPCL

SPCL ON

SYSTEM:KEY

SPCL ON (MHz)

The SPCL ON key (actually the secondary function of the **MHz** key) is used to turn on/off-type special functions on.

The **MHz** (SPCL ON) key is used to turn on/off-type special functions on when they are displayed in the display. The on/off-type special functions are ATTEN HOLD ON/OFF and CLEAR DISPLAY.

The SPCL ON key will turn the special function on whether it has been selected via the numeric keypad or by using the knob or **↑**, **↓** keys. When the special function has been turned on, the word “ON” will be shown in the right side of the display and the SPCL annunciator will be lit.

Equivalent SCPI Command

There is no equivalent SCPI command for the SPCL ON key, however, sending the “SYST:KEY 42” command is effectively the same as pressing the SPCL ON key.

See Also

ATTEN HOLD ON/OFF
CLEAR DISPLAY
SPCL
SPCL OFF
SYSTem:KEY

STEP SIZE

The **STEP SIZE** key enables you to change the increment value for the current active parameter. The increment value is the value that the current parameter will be increased or decreased by when the **↑** or **↓** keys are pressed.

The preset increment value for each parameter can be found under the pertinent key/function entries in this section.

If the **SHIFT** (ENTRY OFF), **⇒** function has been enabled, you will not be able to change any increment values using the **STEP SIZE** key and pressing the **↑** or **↓** keys will have no effect on the active parameter.

Equivalent SCPI Commands

<code>FREQ:STEP <u>increment</u></code>	<i>sets frequency increment value as defined by the “increment” parameter.</i>
<code>FREQ:MULT:STEP <u>increment</u></code>	<i>sets multiplier increment value as defined by the “increment” parameter.</i>
<code>POW:STEP <u>increment</u></code>	<i>sets power level increment value as defined by the “increment” parameter.</i>
<code>POW:ALC:PMET:STEP <u>increment</u></code>	<i>sets external power meter leveling increment value as defined by the “increment” parameter.</i>

See Also



ENTRY OFF

Special Functions

Special Functions

This chapter contains detailed information on the various special functions available for the synthesizer. Special functions are hidden during normal synthesizer operation and can only be invoked by pressing the **(SPCL)** key and then entering the special function number or by scrolling through the list with the **(↑)** and **(↓)** keys. Note that special functions are organized in this chapter alphabetically by special function name, not by special function number.

ATTEN HOLD ON/OFF

Invoking the ATTEN HOLD ON/OFF function (pressing **[SPCL]**, **[2]**, **[Hz]** (ENTER)) selects the attenuator hold function. This function toggles between locking and unlocking the 10 dB step attenuator in its current setting.

NOTE

The attenuator hold function is only available if Option 1E1 is installed.

When **[SPCL]**, **[2]**, **[Hz]** (ENTER) is pressed, the display shows the following:

ATTEN HOLD XXX

where XXX is the current state of the step attenuator (ON= Locked and OFF=Unlocked).

Once the attenuator hold function is enabled, pressing **[MHz]** (SPCL ON) locks the synthesizer step attenuator at its current setting. Pressing **[kHz]** (SPCL OFF) unlocks the step attenuator.

When the synthesizer is set to the preset state, the attenuator hold function is turned off.

Applications

The attenuator hold function can be used to extend the vernier range to prevent the step attenuator from switching between two attenuator settings. Locking the step attenuator keeps the attenuator from switching between the two levels as leveled power is varied above and below the threshold level, thus saving wear on the attenuator. Refer to the specification table in Chapter 4 for the level at which the attenuator switches.

Advantages

Locking the step attenuator prevents switching between two levels when the leveled output power is set near an attenuator switching threshold.

Disadvantages

When the step attenuator is locked, the output power dynamic range is limited to the vernier range at the current output frequency. Locking the step attenuator typically extends the lower limit of the vernier range by 5 dB.

The upper limit of the vernier range is the synthesizer maximum output power which changes with frequency. The minimum dynamic range when the attenuator hold function is on is typically 19 dB.

NOTE

The attenuator hold function on or off will not activate when the synthesizer is in the external diode detector leveling or external power meter leveling mode.

Equivalent SCPI Command

`POW:ATT:AUTO ON|OFF` *turns the attenuator hold function on or off. When the parameter is set to “on”, the attenuator hold function is off and when the parameter is set to “off”, the attenuator hold function is on.*

See Also

POWER LEVEL

`[SOURce[1]:]POWer:ATTenuation:AUTO`

CLEAR DISPLAY

Invoking the clear display function (pressing **SPCL**, **3**, **Hz** (ENTER)) enables you to turn off the synthesizer fluorescent display and LED annunciators or turn them on if they are currently turned off.

When **SPCL**, **3**, **Hz** (ENTER) is pressed, the display will show the following:

```
CLEAR DISPLAY XXX
```

where XXX is “ON” if the clear display function is currently on and “OFF” if the clear display function is currently off.

Once the clear display function has been enabled, pressing **SPCL ON** blanks the display and LED annunciators and **DISPLAY BLANKED** is shown across the display.

The display state is stored in the instrument state registers along with other instrument state data, so if sensitive instrument settings are stored to a register, the settings are not revealed when the register is recalled.

When the synthesizer is set to the preset state, the display is restored if it had been previously cleared.

NOTE

Cycling the POWER switch off and then on will not restore the display.

Equivalent SCPI Command

DISP:STAT ON|OFF *turns the display on or off.*

See Also

Display
DISPlay[:WINDow][:STATe]

ERASE MEMORY

Invoking the ERASE MEMORY function (pressing **[SPCL]**, **[4]**, **[Hz]** (ENTER)) clears all application-specific information from synthesizer memory.

When **[SPCL]**, **[4]**, **[Hz]** (ENTER) is pressed, all user settings are set to the preset state, save/recall registers are erased, and level correction tables are cleared. The ERASE MEMORY function does not clear factory calibration data stored in the EEPROM.

When the ERASE MEMORY function is invoked, the display will momentarily display the following:

```
INITIALIZING MEMORY
```

Application

The ERASE MEMORY function is useful when removing the synthesizer from a secure area as the setup history of the synthesizer will be erased.

Equivalent SCPI Command

`MEM:RAM:INIT` *clears synthesizer memory.*

See Also

PRESET

RCL CR

RECALL

SAVE

SAVE CR

MEMory:RAM:INITialize[:ALL]

PWR MTR ADDRS

Invoking the PWR MTR ADDRS (power meter address) function (pressing **SPCL**, **20**, **Hz** (ENTER)) changes the HP-IB address that the synthesizer uses when communicating with an external power meter during the level correct routine.

When **SPCL**, **20**, **Hz** is pressed, you will be prompted to enter the address that the synthesizer will use when communicating with the external power meter or when receiving data from the external power meter during the level correct routine. The valid power meter address range is 00 to 30 (decimal).

The external power meter HP-IB address set at the factory is 13. Setting the synthesizer to the preset state will not modify the address.

NOTE

This function *does not* set the address at the power meter. You should refer to the power meter manual for information on how to change the power meter address.

Equivalent SCPI Command

`SYST:COMM:PMET:ADDR address` *changes the HP-IB address that the synthesizer uses when communicating with an external power meter as defined by the “address” parameter.*

See Also

LVL CR
LVL CR ON/OFF
PWR MTR SELECT
RCL CR
SAVE CR
SYSTEM:COMMunicate:PMETER:ADDRESS
“To Use the Level Correct Routine” in Chapter 3

PWR MTR SELECT

Invoking the power meter select function (pressing **(SPCL)**, **(21)**, **(Hz)** (ENTER)) allows you to set the programming language that the synthesizer will use when communicating with the power meter during the level correct routine.

When **(SPCL)**, **(21)**, **(Hz)** (ENTER) is pressed, the display shows the following:

```
POWER METER IS  XXX
```

where XXX is the currently selected power meter language (HP70100A, HP437B, HP438A, or SCPI).

Once the power meter select function is enabled, you can use the **(↑)** or **(↓)** keys to choose one of the four power meter language options. When “SCPI” is chosen, the synthesizer will communicate with any SCPI-compatible power meter.

When the synthesizer is set to the preset state, the power meter language chosen with this command is not changed.

Equivalent SCPI Command

There is no equivalent SCPI command for the power meter select function.

See Also

LVL CR

LVL CR ON/OFF

PWR MTR ADDRS

RCL CR

SAVE CR

“To Use the Level Correct Routine” in Chapter 3

REMOTE LANGUAGE

Invoking the remote language function (pressing **SPCL**, **25**, **HZ** (ENTER)) allows you to manually choose either SCPI (Standard Commands for Programmable Instruments) or HP 8673 compatible language.

When **SPCL**, **25**, **HZ** (ENTER) is pressed, the left-most display shows the following:

```
REMOTE LANG IS XXX
```

where XXX is the currently selected language (SCPI or HP 8673).

Once the remote language function is enabled, you can use the **↑** or **↓** keys to toggle between SCPI or HP 8673 language options.

When the synthesizer is set to the preset state, the language chosen with this command is not changed. The language will default to SCPI when the ERASE MEMORY function is executed.

Equivalent SCPI Command

```
SYSTem:LANGuage "SCPI"|"COMP=8673" selects either SCPI or HP 8673  
compatible language.
```

See Also

ERASE MEMORY

SELF TEST

Invoking the self test function (pressing **[SPCL]**, **[5]**, **[Hz]** (ENTER)) enables you to cause the synthesizer to run a functional verification (self test) on itself.

When **[SPCL]**, **[5]**, **[Hz]** (ENTER) **[⇐]** (ENTRY OFF) is pressed, the text SELF TEST?, PRESS ENTER will be shown on the synthesizer display. Pressing **[Hz]** (ENTER) will then cause all self test segments to be run. Pressing any key other than **[Hz]** will cause the self test not to run.

If any of the self test segments fail, error messages will be placed in the error queue to explain the failures. The error messages can then be read either via the front panel or using programming commands. If a particular self test segment failure makes running subsequent self test segments impossible, the self tests will abort.

Notes

1. Running the self test will result in the synthesizer being set to the preset state.
2. It is recommended that you clear the error queue before running the self test.
3. For more information on reading the contents of the error queue, refer to "To Read the Contents of the Error Queue" in Chapter 2 of this manual.
4. Refer to the *HP 83711A/12A and HP 83711B/12B Synthesized CW Generators Service Guide* for a listing of the test segments that are run during the self test.

SELF TEST

Equivalent SCPI Command

*TST? *causes the synthesizer to run a functional verification (self test) on itself.*

See Also

MSG

SYSTEM:ERRor?

“To Read the Contents of the Error Queue” in Chapter 2

*TST?

Service-Related Special Functions

The synthesizer firmware contains several service related routines that can be used when diagnosing faults in its circuitry. Use of these special functions is detailed in the *HP 83711A/12A and HP 83711B/12B Synthesized CW Generators Service Guide* (Option 0B3; HP part number 83711-90134).

The service-related special functions are listed in the following table. They can be accessed by pressing (SPCL), *f-number*, (Hz) (ENTER) where *f-number* is a number from the first column of the table. Details on how to use each special function can be found in the service manual.

Table 7.1. Service-Related Special Functions

Special Function Number	Special Function Name	Description
60	DIRECT CONTROL	Allows direct manipulation of certain data bits within the synthesizer circuitry.
61	METER NODE	Allows entry of a measurement node where the internal volt/ammeter will take a measurement.
62	LO FREQ	Displays the synthesizer internal LO phase locked loop frequency.
63	OFFSET FREQ	Displays the synthesizer internal Offset phase locked loop frequency.
70	HOLD POWER ON/OFF	Holds the power loop at its current setting.
71	CAL YIG OSC	Recalibrates the YIG oscillator and stores the new tuning curve in EEPROM.

See Also

HP 83711A/12A and 83711B/12B Synthesized CW Generators Service Guide

SHOW INFO

Invoking the SHOW INFO (show information) function (pressing **SPCL**, **1**, **Hz** (ENTER)) displays the software version number and instrument serial number on the synthesizer display.

When **SPCL**, **1**, **Hz** is pressed, the following text will be shown on the synthesizer display.

```
SW: X.X SERIAL: YYYYYYYYYY
```

where X.X is the version number of the software currently installed in the synthesizer and YYYYYYYYYY is the synthesizer serial number.

Equivalent SCPI Command

There is no equivalent SCPI command for the SHOW INFO function, however, the “*IDN?” query returns the synthesizer model number, serial number, and firmware revision number.

See Also

*IDN?

Error Messages

Error Messages

If an error condition occurs in the synthesizer, it will always be reported to both the front panel and HP-IB error queues. These two queues are viewed and managed separately. The **MSG** key is used to view the contents of the front panel error queue. The HP-IB query “SYSTem:ERRor?” is used to view the contents of the HP-IB error queue.

If there are any error messages in the front panel error queue, the front panel **MSG** annunciator will be lit. Pressing the **MSG** key repeatedly until the **MSG** annunciator turns off will empty the front panel error queue. The **MSG** key has no affect on the HP-IB error queue. Emptying the HP-IB error queue has no affect on the front panel queue, therefore, it will not affect the **MSG** annunciator.

There are some special error types that are called permanent errors. Permanent errors remain in the error queues until the error condition is cleared. Pressing the **MSG** key will empty the front panel error queue, but the permanent errors will be re-reported if the error conditions still exist. In the HP-IB error queue, the permanent errors are re-reported after the message, 0, “No error” is read using the “SYSTem:ERRor?” query or after the “*CLS” command is executed.

Error Messages List

The list of error messages in this chapter lists all of the error messages associated with synthesizer operation. An example of the error format found in the list of error messages is as follows:

2003 **–222, "Data out of range;CW FREQ(2003)"**

Select a CW frequency that is within range of the installed options. If other modules or options are installed that extend the CW frequency range of the signal generator, this frequency range will be extended also.

The following explains each element of an error message listing.

- **Manual Error Number** – The number 2003 to the left and in the parenthesis is called the Manual Error Number. The error message list is organized in ascending order off the manual error number. The manual error number will always be found in the parenthesis contained in the message.
- **Error Message** – The bold text **–222, "Data out of range;CW FREQ(2003)"** is the error message. When the **MSG** key is pressed, the error message is displayed in the left-most display. The entire message is returned by the HP-IB query "SYSTem:ERRor?". The error message contains the following parts:
 - **SCPI Error Number** – The standard SCPI error number (–222 in the example) usually differs from the manual error number because the manual error number is unique for every possible message. Standard SCPI error numbers are always negative (except for 0, "No error"). If there is no standard SCPI error number for a message, the manual error number replaces it in the error message.
 - **SCPI Error Message** – The SCPI error message is **Data out of range** in the example.
 - **Detailed Description** – All information after the semicolon is a detailed description of what exactly caused the error. In the example, **CW FREQ** tells you that CW frequency was out of range. If no detailed description exists, it will be omitted from the message.

Error Messages List

- **Action Required** – The text that appears below each error message listing contains corrective actions that should be followed in order to correct the error condition.

Notes

1. For more information related to error messages, refer to “To Read the Contents of the Error Queue” in Chapter 2 or the “MSG” reference entry in Chapter 6 of this manual, and the “SYSTem:ERRor?” reference entry in Chapter 1 of this manual.
2. Error messages related to hardware failures are listed in the *HP 83711A/12A and HP 83711B/12B Synthesized CW Generators Service Guide* (HP part number 83711-90134).

Messages

The following pages list all error messages in ascending manual error number order:

- 440 –440, "Query UNTERMINATED after indefinite response;(–440)"

Correct the HP-IB controller program so that the query that returns indefinite length block data is the last item on the program line.
- 430 –430, "Query DEADLOCKED;(–430)"

Correct the HP-IB controller program so that no more than eight queries are executed within the same line of the program.
- 420 –420, "Query UNTERMINATED;(–420)"

Correct the HP-IB controller program so that the controller terminates commands with the newline character (NL) before the controller attempts to read query response data.
- 410 –410, "Query INTERRUPTED;(–410)"

Check the HP-IB controller program to see if the controller is programmed to read the entire query response data before issuing a subsequent command.
- 400 –400, "Query error;(–400)"

Some problem occurred while parsing an HP-IB query. Insure that your programming is correct and try the query again. Look at –440 through –400 for types of problems to look for.
- 350 –350, "Queue overflow"

The error queue overflowed at this point and this message replaced the 16th error message. No action is required. Note: To clear the HP-IB error queue, use *CLS.
- 330 –330, "Self test failed;(–330)"

See the explanation for error number 4000.
- 315 –315, "Configuration memory lost;(–315)"

See error 1803.
- 314 –314, "Save/recall memory lost;(–314)"

Messages

See error 1803.

–311 –311,"Memory error;(-311)"

See error 1803.

–310 –310,"System error;(-310)"

Some problem occurred while parsing an HP-IB command or query. Insure that your programming is correct and try the command again.

–300 –300,"Device specific error;(-300)"

A remote command or query could not be executed because an error occurred in the synthesizer.

–278 –278,"Macro header not found;(-278)"

A *GMC? or *RMC macro label could not be found in the list of defined macro labels. Use *LMC? to get a list of all the currently defined macro labels.

–277 –277,"Macro redefinition not allowed;(-277)"

Indicates that a macro label in the *DMC command could no be defined because the macro label was already defined.

–276 –276,"Macro recursion error;(-276)"

The nesting/recursion of macros is deeper than 4 levels. Don't use more than 4 levels when defining macros of macros.

–275 –275,"Macro definition too long;(-275)"

The macro definition must be 255 characters or less.

–274 –274,"Macro parameter error;(-274)"

A macro parameter placeholder was improperly used.

–273 –273,"Illegal macro label;(-273)"

Indicates that a macro label defined in the *DMC command has a legal string syntax; but, it is too long. It is the same as a common command header, or contain invalid header syntax.

–272 –272,"Macro execution error;(-272)"

Indicates that a syntactically legal macro program data sequence could not be executed due to some error in the macro definition.

- 271 –271, "Macro syntax error;(–271)"
Indicates that a syntax error exists in the macro definition.
- 270 –270, "Macro error;(–270)"
An error occurred while attempting to define, query or use a macro. Check that the macros are correct using *LMC? and *GMC?.
- 261 –261, "Math error in expression;(–261)"
An expression could not be evaluated due to a math error; for example, a divide-by-zero was attempted.
- 260 –260, "Expression error;(–260)"
An expression could not be evaluated because it contains an error.
- 241 –241, "Hardware missing;(–241)"
The requested hardware does not exist in the synthesizer. Use *OPT? to check which options are installed.
- 240 –240, "Hardware error;(–240)"
The remote command or query could not be executed because of a hardware error.
- 226 –226, "Tables not same length;(–226)"
See error 731.
- 225 –225, "Out of memory;(–225)"
The synthesizer has run out of memory. The memory requested has not been allocated.
- 224 –224, "Illegal parameter value;(–224)"
Correct the HP-IB controller program so that the data included with the HP-IB command is an acceptable parameter for the command.
- 223 –223, "Too much data;(–223)"
Correct the HP-IB controller program so that there is less data on a single command line. The synthesizer does not have enough memory to buffer it all.
- 222 –222, "Data out of range;(–222)"

Messages

The parameter data was out of range. Unlike other –222 errors, details are not known about the command or query which caused this error.

–221 –221,"Settings conflict;(–221)"

The current synthesizer state does not allow the remote command or query to be executed.

–220 –220,"Parameter error;(–220)"

The parameter included with the remote command or query is incorrect.

–213 –213,"Init ignored;(–213)"

Indicates that an initiate was ignored because a trigger was already in progress.

–212 –212,"Arm ignored;(–212)"

An arming signal was received and recognized but was ignored.

–211 –211,"Trigger ignored;(–211)"

A GET, *TRG or triggering signal was received and recognized but was ignored. Currently, there is no bus trigger capability in the synthesizer.

–210 –210,"Trigger error;(–210)"

A trigger error occurred in the synthesizer.

–201 –201,"Invalid while in local;(–201)"

The remote command or query cannot be executed when the synthesizer is in local mode.

–200 –200,"Execution error;(–200)"

Some problem occurred while executing an HP-IB command or query. Insure that your programming is correct and try the command again.

–184 –184,"Macro parameter error;(–184)"

Indicates that a command inside the macro definition had the wrong number or type of parameters.

–183 –183,"Invalid inside macro definition;(–183)"

Indicates that the program message sequence sent with *DMC or *DDT command is syntactically invalid.

- 181 –181, "Invalid outside macro definition;(-181)"
Indicates that a macro parameter placeholder was encountered outside of the macro definition.
- 180 –180, "Macro error;(-180)"
An error occurred while attempting to define, query or use a macro. Check that the macros are correct using *LMC? and *GMC?.
- 178 –178, "Expression data not allowed;(-178)"
Correct the HP-IB controller program so that the data included with the HP-IB command does not contain parentheses.
- 171 –171, "Invalid expression;(-171)"
The expression contained a syntax error like unmatched parenthesis or an illegal character.
- 170 –170, "Expression error;(-170)"
The expression contains a syntax error.
- 168 –168, "Block data not allowed;(-168)"
Correct the HP-IB controller program so that the data included with the HP-IB command does not contain block data (no # character).
- 161 –161, "Invalid block data;(-161)"
Correct the HP-IB controller program so that it contains a correct block data type. A block data type should begin with "#" followed by a number.
- 160 –160, "Block data error;(-160)"
The block data contains a syntax error.
- 158 –158, "String data not allowed;(-158)"
Correct the HP-IB controller program so that the data included with the HP-IB command does not contain string data (no single or double quote characters).
- 151 –151, "Invalid string data;(-151)"
Correct the HP-IB controller program so that the string data included with the HP-IB command is terminated with a single or double quote. The terminating quote must be the same as the leading quote of the

Messages

string. A string can also be valid if invalid characters are contained in it.

–150 –150,"String data error;(–150)"

The string data was too long to be buffered in the synthesizer string data area.

–148 –148,"Character data not allowed;(–148)"

Correct the HP-IB controller program so that the data included with the HP-IB command is not character data.

–144 –144,"Character data too long;(–144)"

The character data element contains more than 12 characters.

–141 –141,"Invalid character data;(–141)"

Either the character data element contains an invalid character or the particular element is not valid for the command or query.

–140 –140,"Character data error;(–140)"

The character data contains a syntax error.

–138 –138,"Suffix not allowed;(–138)"

Correct the HP-IB controller program so that the decimal data included with the HP-IB command does not use a suffix. Use exponential notation instead.

–134 –134,"Suffix too long;(–134)"

The suffix contained more than 12 characters.

–131 –131,"Invalid suffix;(–131)"

Correct the HP-IB controller program so that the decimal data included with the HP-IB command contains a valid suffix for that command or query.

–130 –130,"Suffix error;(–130)"

The suffix contains a syntax error.

–128 –128,"Numeric data not allowed;(–128)"

Correct the HP-IB controller program so that the data included with the HP-IB command is not numeric data.

- 124 –124, "Too many digits;(–124)"
The mantissa of a decimal numeric data element contained more than 255 digits excluding leading zeros.
- 123 –123, "Exponent too large;(–123)"
The magnitude of the exponent was larger than 32000.
- 121 –121, "Invalid character in number;(–121)"
Correct the HP-IB controller program so that the decimal data or non-decimal numeric included with the HP-IB command contains the correct numeric characters.
- 120 –120, "Numeric data error;(–120)"
An invalid numeric or non-decimal numeric was parsed but it was syntactically invalid.
- 114 –114, "Header suffix out of range;(–114)"
Indicates that a header suffix was too large.
- 113 –113, "Undefined header;(–113)"
The header is syntactically correct, but it is undefined for the synthesizer.
- 112 –112, "Program mnemonic too long;(–112)"
The header contains more than 12 characters.
- 111 –111, "Header separator error;(–111)"
An illegal header separator was encountered while parsing the header.
- 110 –110, "Command header error;(–110)"
An error was detected in the header.
- 109 –109, "Missing parameter;(–109)"
This error indicates that an HP-IB command or query has too few parameters. Correct the HP-IB controller program so that the HP-IB command or query contains the correct number of parameters.
- 108 –108, "Parameter not allowed;(–108)"

Messages

This error indicates that an HP-IB command or query has too many parameters. Correct the HP-IB controller program so that the HP-IB command or query contains the correct number of parameters.

–105 –105,"GET not allowed;(-105)"

Correct the HP-IB controller program so that the group execute trigger does not occur within a line of HP-IB program code.

–104 –104,"Data type error;(-104)"

The parser recognized a data element different than one allowed. For example, numeric or string data was expected but block data was encountered.

–103 –103,"Invalid separator;(-103)"

A separator was expected but an illegal character was encountered. For example, the space is missing from the following: `FREQ.01GHz`.

–102 –102,"Syntax error;(-102)"

An unrecognized command or data type was encountered.

–101 –101,"Invalid character;(-101)"

A syntactic element contains a character which is invalid for that type. For example, a header containing an ampersand would give this error.

–100 –100,"Command error;(-100)"

Some problem occurred while parsing an HP-IB command or query. Insure that your programming is correct and try the command again.

0 0,"No error"

The error queue contains no errors.

110 110,"EEPROM unprotected;(110)"

The PG switch is set to 0 which leaves the EEPROM unprotected. Open up the synthesizer and switch the PG switch to 1. This error message is only a warning.

511 511,"YTO cal data init error;(511)"

The YIG oscillator factory calibration data checksum was incorrect. A new YIG calibration should be performed or else the instrument may be unable to attain lock at some frequencies.

- 600 600, "ALC loop went unlevel;(600)"
Power is set to a level that is higher than the instrument can supply. This is usually due to attenuator hold and the power is set to a value that requires the vernier to be operating out of its specified range. Change the power level or turn off attenuator hold. This is a "permanent" error.
- 601 601, "Hardware driver Power limit;(601)"
Due to instrument specials such as attenuator hold, the circuits cannot supply the specified power. Change the power level or turn off attenuator hold. This is a "permanent" error.
- 602 602, "Vernier has been set to the limit;(602)"
Due to instrument options such as attenuator hold, the circuits cannot supply the specified power. The vernier has been limited to a valid value. Change the power level or turn off attenuator hold. This is a "permanent" error.
- 603 603, "RF on/off command not valid;(603)"
An invalid request to turn off RF power was ignored by the instrument.
- 604 604, "Atten driver error while setting level;(604)"
The attenuators could not be set to the range requested. Change output power to a valid setting.
- 605 605, "Vernier driver error while setting level;(605)"
The vernier value requested was not possible. Change output power to a valid setting.
- 606 606, "Level is not in guaranteed range.:(606)"
The power level requested is beyond specifications and may be invalid. This could be due to a very low vernier setting required when attenuator hold is active. This is a "permanent" error.
- 608 608, "Attenuator not set before Ext Meter mode;(608)"
The attenuator range must match that of the meter range desired for external meter ALC mode. Turn off attenuator hold mode and make sure the power meter is in range hold before entering external power meter mode.

Messages

- 610 610, "Track and hold failed, level is invalid;(610)"
Power level was too high to do a power level setting in pulse or scan AM mode. Try setting power to a lower value.
- 611 611, "Track and hold failed, level is invalid;(611)"
Power level was too high to do a power level setting in pulse or scan AM mode. Try setting power to a lower value.
- 650 650, "PG switch not set to 0;(650)"
ALC calibration data was not saved in EEPROM because the PG switch was protecting the EEPROM from "writes". Open up the synthesizer and switch the PG switch to 0.
- 651 651, "Invalid vernier cal data for 1-20 GHz;(651)"
Valid vernier calibration data is not available for the 1-20 GHz band. If you need to use this frequency range, see the explanation for error number 4000.
- 652 652, "ALC term verification after EEPROM write;(652)"
ALC vernier calibration data was not written into EEPROM correctly. Try writing the data into the synthesizer again.
- 653 653, "Invalid vernier cal data for 0.01-1 GHz;(653)"
Valid vernier calibration data is not available for the 0.01-1 GHz band. If you need to use this frequency range, see the explanation for error number 4000.
- 655 655, "PG switch not set to 0;(655)"
Factory frequency correction data was not saved in EEPROM because the PG switch was protecting the EEPROM from "writes". Open up the synthesizer and switch the PG switch to 0.
- 656 656, "Factory flatness cal data verification;(656)"
Factory frequency level calibration data was not written into EEPROM correctly. Try writing the data into the synthesizer again.
- 657 657, "Factory flatness cal data is invalid;(657)"
A valid factory frequency level calibration is not available for one or more of the frequency bands and/or attenuator settings. See the explanation for error number 4000.

- 670 **670, "Meter power input is out of range;(670)"**
The ALC input is not a valid level. The power meter range may be wrong. This is a "permanent" error.
- 700 **700, "Hardware driver Frequency limit;(700)"**
The frequency entered cannot be generated by the synthesizer with the set of options available.
- 701 **701, "Lo synthesizer set error;(701)"**
The LO synthesizer cannot be set to the level requested. Enter a new frequency.
- 702 **702, "Offset synthesizer set error;(702)"**
The offset synthesizer cannot be set to the level requested. Enter a new frequency.
- 704 **704, "YTO driver set error;(704)"**
The YIG oscillator cannot be set to the level requested. Enter a new frequency.
- 706 **706, "Low pass filter set error;(706)"**
The low pass filter cannot be set to the requested setting. Enter a new frequency.
- 709 **709, "Hardware driver Frequency limit;(709)"**
The frequency entered cannot be generated by the Frequency Extension module.
- 710 **710, "LO synthesizer went out of lock;(710)"**
The LO synthesizer went out of lock. This may be due to hookup or disconnection of an external time base. Enter a different RF frequency and then set the frequency back to the desired value to re-lock. This is a "permanent" error.
- 711 **711, "Offset synthesizer went out of lock;(711)"**
The offset synthesizer board was unable to attain lock. Enter a different RF frequency and then set the frequency back to the desired value to re-lock. This is a "permanent" error.
- 712 **712, "Frequency loop went out of lock;(712)"**

Messages

Enter a different RF frequency and then set the frequency back to the desired value to re-lock. This is a “permanent” error.

730 730, “Invalid data in level correct table;(730)”

The active level correction table has no data in it. Select a level correction table with valid data, perform an automatic level correction to get valid data into the active table, or use HP-IB to load the active table. This is a “permanent” error.

731 –226, “Tables not same length;Level correct(731)”

The active level correction table has a mismatch between the number of frequencies stored and the number of losses stored. Select a level correction table with valid data, perform an automatic level correction to get valid data into the active table, or use HP-IB to load tables with the same length. This is a “permanent” error.

732 732, “Same frequencies with different losses;(732)”

The active level correction table has duplicate frequencies with different losses. Select a level correction table with valid data, perform an automatic level correction to get valid data into the active table, or use HP-IB to load tables with non-duplicate frequencies. This is a “permanent” error.

733 733, “Frequency table not in ascending order;(733)”

The MEM:TABL:FREQ command did not contain frequencies in ascending order. The whole MEM:TABL:FREQ command was rejected, leaving the old selected table unaltered.

734 734, “Frequency table not in ascending order;(734)”

The active level correction table does not contain frequencies in ascending order. Select a level correction table with valid data, perform an automatic level correction to get valid data into the active table, or use HP-IB to load a table with ascending ordered frequencies. This is a “permanent” error.

735 735, “Level correct points less than 2;(735)”

The number of points in a level correction table must be from 2 to 401. Either too few points were entered or duplicate frequencies caused the number of “real” points to shrink below 2.

736 736, “Factory level corr 1-20 GHz, 1-9 table;(736)”

Factory frequency level correction data for 1-20 GHz band, non-thru paths are not valid. If you need to use this frequency range and you are using a step attenuator, see the explanation for error number 4000.

737 737, "Factory level corr 0.01-1 GHz, 1-9 table;(737)"

Factory frequency level correction data for 0.01-1 GHz band, non-thru paths are not valid. If you need to use this frequency range and you are using a step attenuator, see the explanation for error number 4000.

738 738, "Factory level corr 0.01-1 GHz, 0 dB table;(738)"

Factory frequency level correction data for 0.01-1 GHz band, thru path is not valid. If you need to use this frequency range and you work with output levels that don't use the step attenuator, see the explanation for error number 4000.

739 739, "Invalid data in table, not recalled;(739)"

This error indicates that a level correction table recall failed. Try selecting the same level correction table again. If this error message persists you will have to recreated the saved table.

740 740, "Another controller is on the HP-IB bus;(740)"

An automatic level correction was attempted but failed because there is a controller on the HP-IB bus. Remove all controllers from the HP-IB bus and try again.

741 741, "No HP-IB devices found;(741)"

An automatic level correction was attempted but failed to find any other devices on the HP-IB bus. Connect the desired power meter to the HP-IB bus and try again. Check the HP-IB cable(s) for loose connections.

742 742, "Errors in cleanup of HP-IB;(742)"

When exiting the automatic level correction, the synthesizer failed to finish resetting the HP-IB bus and presetting the power meter. Make sure the power meter address matches the power meter address setting on the synthesizer. Check the HP-IB cable(s) for loose connections.

743 743, "No HP-IB devices found;(743)"

An automatic level correction was attempted but failed to find any other devices on the HP-IB bus. Connect the desired power meter to

Messages

the HP-IB bus and try again. Make sure the power meter address matches the power meter address setting on the synthesizer. Check the HP-IB cable(s) for loose connections.

744 744,"Cannot find power meter on HP-IB bus;(744)"

An automatic level correction was attempted but failed to find a power meter on the HP-IB bus. Connect the desired power meter to the HP-IB bus and try again. Make sure the power meter address matches the power meter address setting on the signal generator. Check the HP-IB cable(s) for loose connections.

745 745,"Meter returns error msg;(745)"

While running the automatic level correction, the power meter returned +9.0000E+40 as the power reading. This number indicates an error within the power meter.

746 746,"Data measured is invalid or out of range;(746)"

While running the automatic level correction, the power meter returned an out of range power reading or the power meter returned a non-number as its power reading. Check that the power meter is reading an appropriate value by looking at it.

747 747,"Unable to receive msg from meter;(747)"

An automatic level correction was attempted but failed to power readings back from the power meter. Make sure the power meter address matches the power meter address setting on the synthesizer. Check the HP-IB cable(s) for loose connections.

748 748,"Erasing corrupted level correct table;(748)"

A level correction table was corrupt and was erased to fix it.

749 749,"Frequency not within level correct data;(749)"

This message is a warning that the current CW frequency is not contained within the frequencies in the active level correction table. Therefore, the correction applied to the output will be 0 dB. This is a "permanent" error.

751 751,"Parameters cause points to be too large;(751)"

The level correction parameters cannot define a new table because they create too many level correction points.

- 752 -222, "Data out of range;Data set to minimum(752)"
Loss data must be in the range of -40 to +40 dB.
- 753 -222, "Data out of range;Data set to maximum(753)"
Loss data must be in the range of -40 to +40 dB.
- 754 754, "Total points reduced from that requested;(754)"
The number of points requested for an automatic level correction has been reduced to avoid duplicate frequencies.
- 755 755, "Invalid data in active table, not saved;(755)"
This error indicates that a level correction table save failed. Try selecting the same level correction table again. If this error message persists you will have to recreate the table.
- 756 756, "Factory level corr 1-20 GHz, 0 dB table;(756)"
Factory frequency level correction data for 1-20 GHz band, thru path is not valid. If you need to use this frequency range and you work with output levels that don't use the step attenuator, see the explanation for error number 4000.
- 757 757, "Bad attenuator setting parameter;(757)"
The attenuator range for looking up factory frequency level correction data, is 0 through 120 (resolution is 10).
- 758 -222, "Data out of range;Data set to minimum(758)"
Loss data for factory frequency level correction was less than minimum.
- 759 -222, "Data out of range;Data set to maximum(759)"
Loss data for factory frequency level correction was more than maximum.
- 760 760, "Bad index into data table;(760)"
A data lookup from a calibration table found that the index data is out of range. Try setting the same synthesizer function again. If this error message persists, run the instrument self test.
- 761 761, "Bad index into offset table;(761)"

Messages

A data lookup from the factory level correction offset table found that the index data is out of range. Try setting the same synthesizer function again. If this error message persists, run the instrument self test.

763, "Unable to write to EEPROM;(763)"

A calibration table was not loaded into EEPROM because the EEPROM was protected or the EEPROM load did not verify. Open up the synthesizer and switch the PG switch to 0.

764, "Unable to write to RAM;(764)"

A write to RAM failed to verify. Run the self test routine to check RAM for problems.

765, "Attempt to write to ROM;(765)"

There was an attempt to write calibration data to ROM. This should not occur, but if it does, try setting the same synthesizer function again. If this error message persists, run the instrument self test.

766, "Number of writes to EEPROM exceeds max;(766)"

The number of EEPROM writes has exceeded the maximum allowed. However, the data was written to the EEPROM anyway. This is only a warning; but, you should check to make sure your data was correctly stored in EEPROM.

770, "YTO cal data invalid;(770)"

The YIG oscillator factory calibration data checksum was incorrect. Select the CAL YIG OSC feature to perform a YIG oscillator calibration. If you do not re-calibrate, the synthesizer may be unable to attain lock at some frequencies.

771, "Invalid YIG DAC value in cal table.:(771)"

The YIG oscillator factory calibration data checksum was incorrect. Select the CAL YIG OSC feature to perform a YIG oscillator calibration. If you do not re-calibrate, the synthesizer may be unable to attain lock at some frequencies.

772, "YTO cal values for Up/Down search vary;(772)"

The YIG oscillator factory calibration data checksum was incorrect. Select the CAL YIG OSC feature to perform a YIG oscillator calibration.

If you do not re-calibrate, the synthesizer may be unable to attain lock at some frequencies.

774 774,"EEPROM protected, YTO cal aborted;(774)"

An automatic YIG oscillator calibration was not performed because the PG switch was protecting the EEPROM from "writes". Open up the synthesizer and switch the PG switch to 0.

775 775,"Low band yto cal failed;(775)"

The low band calibration failed and the data for the calibration was not saved. Re-try the YIG calibration and watch for the default cal points indicated when the DAC value shown for a given point says 'dflt = ' instead of 'DAC = '.

776 776,"High band yto cal failed;(776)"

The low band calibration failed and the data for the calibration was not saved. Re-try the YIG calibration and watch for the default cal points indicated when the DAC value shown for a given point says 'dflt = ' instead of 'DAC = '.

777 777,"Low band yto cal could not write EEPROM;(777)"

The data for the low band YIG calibration could not be written to EEPROM. Make sure the PG switch on the processor board was closed during the cal and re-try the YIG calibration.

778 778,"High band yto cal could not write EEPROM;(778)"

The data for the low band YIG calibration could not be written to EEPROM. Make sure the PG switch on the processor board was closed during the cal and re-try the calibration.

779 779,"Only 2GHz or 10GHz allowed for YTO Cal;(779)"

The start frequency specified for the CAL:YIG:FREQ:START command was not valid. Re-enter the start frequency and start the YIG calibration again.

785 785,"Cal Data not saved, PG switch is not 0;(785)"

The calibration data could not be saved because the PG switch on the microprocessor board was not closed. Close the PG switch and do the calibration again.

786 786,"Cal Data verification after EEPROM write;(786)"

Messages

The calibration data was not written correctly after the calibration. Close the PG switch and do the calibration again.

787 787,"FM cal and Pinchoff cal not initialized;(787)"

The YIG calibration has not been done for both YIG bands or else the pinchoff cal values have not been entered yet.

790 790,"Scan-mod 0.01-1 GHz gain tables bad;(790)"

Checksum was invalid for the AM gain tables. If you need to use this frequency range and scan AM modulation, see the explanation for error number 4000.

793 793,"Scan AM cal not valid, defaults used;(793)"

Scan AM level may be in error due to invalid calibration data. If you need to use scan AM modulation, see the explanation for error number 4000.

794 794,"Scan-mod 1-20 GHz gain tables bad;(794)"

Checksum was invalid for the AM scan gain tables. If you need to use this frequency range and scan AM modulation, see the explanation for error number 4000.

795 795,"Scan-mod 1-20 GHz linear 1 tables bad;(795)"

Checksum was invalid for the AM scan linear 1 tables. If you need to use this frequency range and scan AM modulation, see the explanation for error number 4000.

796 796,"Scan-mod 1-20 GHz linear 2 tables bad;(796)"

Checksum was invalid for the AM scan linear 2 tables. If you need to use this frequency range and scan AM modulation, see the explanation for error number 4000.

800 800,"Options not saved, PG switch is not 0;(800)"

The instrument option bit-fields were not saved to EEPROM. Open up the synthesizer, switch the PG switch to 0, and try setting the option bit-fields again.

801 801,"Serial num not saved, PG switch is not 0;(801)"

The instrument serial number was not saved to EEPROM. Open up the synthesizer, switch the PG switch to 0, and try setting the serial number again.

- 802 802, "Assembly Revs not saved, PG switch is not 0 (802)"
The protection switch on the CPU board is in an incorrect position to change EEPROM data.
- 803 803, "EEPROM not cleared, PG switch is not 0 (803)"
The protection switch on the CPU board is in an incorrect position to clear EEPROM data.
- 900 900, "PRI increased to fit pulse width;(900)"
The current pulse width is too large for the current PRI. The PRI is increased to allow for the pulse width. This is a "permanent" error.
- 901 901, "Delay and width decreased to fit max PRI;(901)"
The current pulse width plus the current pulse delay is too large because they are greater than the maximum PRI. The delay and/or the width were reduced to fit. This is a "permanent" error.
- 940 940, "Oven is cold;(940)"
The high stability time base oven is cold. The oven must be allowed to warm up before proper instrument operation will occur. This is a "permanent" error.
- 944 944, "Reference synthesizer went out of lock;(944)"
The reference synthesizer went out of lock. The out of lock condition may have been due to an external time base being connected or disconnected. Enter a different RF frequency and then set the frequency back to the desired value to re-lock. This is a "permanent" error.
- 1101 1101, "Loop number is invalid.:(1101)"
If you are using the direct hardware control service feature, you have entered an out of range value. If this error occurs while not using the direct hardware control service feature, low level hardware drivers could not set the requested synthesizer setting. Try setting the synthesizer again. If this error message persists, run the instrument self test.
- 1102 1102, "Start bit is negative.:(1102)"
See the explanation for error number 1101.
- 1103 1103, "Length less than 0 or more than 32;(1103)"

Messages

See the explanation for error number 1101.

1104 1104, "Start bit is invalid for given loop.;"(1104)"

See the explanation for error number 1101.

1105 1105, "Length is invalid for given loop;"(1105)"

See the explanation for error number 1101.

1106 1106, "Data is too large for given length;"(1106)"

See the explanation for error number 1101.

1107 -222, "Data out of range;Bit field number(1107)"

See the explanation for error number 1101.

1108 -222, "Data out of range;Query port field(1108)"

If you are using the direct hardware control service feature, you have entered an out of range query address. If this error occurs while not using the direct hardware control service feature, low level hardware drivers could not complete a query. Try setting the synthesizer again. If this error message persists, run the instrument self test.

1109 1109, "Query Port mode;"(1109)"

See the explanation for error number 1108.

1462 1462, "Keybd processor reports status error;"(1462)"

A key press was not successful. Try pressing the same key again. If the error message persists, see the explanation for error number 4000.

1463 1463, "Keybd processor data lines incorrect;"(1463)"

A key press was not successful. Try pressing the same key again. If the error message persists, see the explanation for error number 4000.

1501 -302, "8673 command not recognized (1501)"

While in HP 8673 emulation mode, an incoming command string was not recognized as being valid. Refer to the front-panel error que for the command sequence.

1511 -301, "8673 command K0 not emulated (1511)"

The above command is recognized by the synthesizer in HP 8673 emulation mode, but it is not emulated. The command is thus

discarded and no action is taken. Refer to Chapter 4 of the *HP 8673 Compatibility Guide* for more information.

1512 –301, "8673 command K1 not emulated (1512)"

The above command is recognized by the synthesizer in HP 8673 emulation mode, but it is not emulated. The command is thus discarded and no action is taken. Refer to Chapter 4 of the *HP 8673 Compatibility Guide* for more information.

1513 –301, "8673 command Mn not emulated (1513)"

The above command is recognized by the synthesizer in HP 8673 emulation mode, but it is not emulated. The command is thus discarded and no action is taken. Refer to Chapter 4 of the *HP 8673 Compatibility Guide* for more information.

1514 –301, "8673 command Xn not emulated (1514)"

The above command is recognized by the synthesizer in HP 8673 emulation mode, but it is not emulated. The command is thus discarded and no action is taken. Refer to Chapter 4 of the *HP 8673 Compatibility Guide* for more information.

1515 –301, "8673 command Wn not emulated (1515)"

The above command is recognized by the synthesizer in HP 8673 emulation mode, but it is not emulated. The command is thus discarded and no action is taken. Refer to Chapter 4 of the *HP 8673 Compatibility Guide* for more information.

1516 –301, "8673 command BS not emulated (1516)"

The above command is recognized by the synthesizer in HP 8673 emulation mode, but it is not emulated. The command is thus discarded and no action is taken. Refer to Chapter 4 of the *HP 8673 Compatibility Guide* for more information.

1517 –301, "8673 command L2 not emulated (1517)"

The above command is recognized by the synthesizer in HP 8673 emulation mode, but it is not emulated. The command is thus discarded and no action is taken. Refer to Chapter 4 of the *HP 8673 Compatibility Guide* for more information.

1518 –301, "8673 command _9 not emulated (1518)"

Messages

The above command is recognized by the synthesizer in HP 8673 emulation mode, but it is not emulated. The command is thus discarded and no action is taken. Refer to Chapter 4 of the *HP 8673 Compatibility Guide* for more information.

1519 –301, "8673 command OC not emulated (1519)"

The above command is recognized by the synthesizer in HP 8673 emulation mode, but it is not emulated. The command is thus discarded and no action is taken. Refer to Chapter 4 of the *HP 8673 Compatibility Guide* for more information.

1520 –301, "8673 command CT not emulated (1520)"

The above command is recognized by the synthesizer in HP 8673 emulation mode, but it is not emulated. The command is thus discarded and no action is taken. Refer to Chapter 4 of the *HP 8673 Compatibility Guide* for more information.

1521 –301, "8673 command Nx not emulated (1521)"

The above command is recognized by the synthesizer in HP 8673 emulation mode, but it is not emulated. The command is thus discarded and no action is taken. Refer to Chapter 4 of the *HP 8673 Compatibility Guide* for more information.

1522 –301, "8673 command SU not emulated (1522)"

The above command is recognized by the synthesizer in HP 8673 emulation mode, but it is not emulated. The command is thus discarded and no action is taken. Refer to Chapter 4 of the *HP 8673 Compatibility Guide* for more information.

1523 –301, "8673 command SD not emulated (1523)"

The above command is recognized by the synthesizer in HP 8673 emulation mode, but it is not emulated. The command is thus discarded and no action is taken. Refer to Chapter 4 of the *HP 8673 Compatibility Guide* for more information.

1524 –301, "8673 command Tx not emulated (1524)"

The above command is recognized by the synthesizer in HP 8673 emulation mode, but it is not emulated. The command is thus discarded and no action is taken. Refer to Chapter 4 of the *HP 8673 Compatibility Guide* for more information.

1525 –301, "8673 command TR not emulated (1525)"

The above command is recognized by the synthesizer in HP 8673 emulation mode, but it is not emulated. The command is thus discarded and no action is taken. Refer to Chapter 4 of the *HP 8673 Compatibility Guide* for more information.

1526 –301, "8673 command RS not emulated (1526)"

The above command is recognized by the synthesizer in HP 8673 emulation mode, but it is not emulated. The command is thus discarded and no action is taken. Refer to Chapter 4 of the *HP 8673 Compatibility Guide* for more information.

1527 –301, "8673 command SM not emulated (1527)"

The above command is recognized by the synthesizer in HP 8673 emulation mode, but it is not emulated. The command is thus discarded and no action is taken. Refer to Chapter 4 of the *HP 8673 Compatibility Guide* for more information.

1528 –301, "8673 command _2 not emulated (1528)"

The above command is recognized by the synthesizer in HP 8673 emulation mode, but it is not emulated. The command is thus discarded and no action is taken. Refer to Chapter 4 of the *HP 8673 Compatibility Guide* for more information.

1529 –301, "8673 command _3 not emulated (1529)"

The above command is recognized by the synthesizer in HP 8673 emulation mode, but it is not emulated. The command is thus discarded and no action is taken. Refer to Chapter 4 of the *HP 8673 Compatibility Guide* for more information.

1530 –301, "8673 command _A not emulated (1530)"

The above command is recognized by the synthesizer in HP 8673 emulation mode, but it is not emulated. The command is thus discarded and no action is taken. Refer to Chapter 4 of the *HP 8673 Compatibility Guide* for more information.

1531 –301, "8673 command SV not emulated (1531)"

The above command is recognized by the synthesizer in HP 8673 emulation mode, but it is not emulated. The command is thus

Messages

discarded and no action is taken. Refer to Chapter 4 of the *HP 8673 Compatibility Guide* for more information.

1532 –301, "8673 command OL not emulated (1532)"

The above command is recognized by the synthesizer in HP 8673 emulation mode, but it is not emulated. The command is thus discarded and no action is taken. Refer to Chapter 4 of the *HP 8673 Compatibility Guide* for more information.

1534 –301, "8673 command FA not emulated (1534)"

The above command is recognized by the synthesizer in HP 8673 emulation mode, but it is not emulated. The command is thus discarded and no action is taken. Refer to Chapter 4 of the *HP 8673 Compatibility Guide* for more information.

1535 –301, "8673 command FB not emulated (1535)"

The above command is recognized by the synthesizer in HP 8673 emulation mode, but it is not emulated. The command is thus discarded and no action is taken. Refer to Chapter 4 of the *HP 8673 Compatibility Guide* for more information.

1536 –301, "8673 command FS not emulated (1536)"

The above command is recognized by the synthesizer in HP 8673 emulation mode, but it is not emulated. The command is thus discarded and no action is taken. Refer to Chapter 4 of the *HP 8673 Compatibility Guide* for more information.

1537 –301, "8673 command DF not emulated (1537)"

The above command is recognized by the synthesizer in HP 8673 emulation mode, but it is not emulated. The command is thus discarded and no action is taken. Refer to Chapter 4 of the *HP 8673 Compatibility Guide* for more information.

1538 –301, "8673 command DW not emulated (1538)"

The above command is recognized by the synthesizer in HP 8673 emulation mode, but it is not emulated. The command is thus discarded and no action is taken. Refer to Chapter 4 of the *HP 8673 Compatibility Guide* for more information.

1539 –301, "8673 command SF not emulated (1539)"

The above command is recognized by the synthesizer in HP 8673 emulation mode, but it is not emulated. The command is thus discarded and no action is taken. Refer to Chapter 4 of the *HP 8673 Compatibility Guide* for more information.

1540 –301, "8673 command SP not emulated (1540)"

The above command is recognized by the synthesizer in HP 8673 emulation mode, but it is not emulated. The command is thus discarded and no action is taken. Refer to Chapter 4 of the *HP 8673 Compatibility Guide* for more information.

1541 –301, "8673 command IF not emulated (1541)"

The above command is recognized by the synthesizer in HP 8673 emulation mode, but it is not emulated. The command is thus discarded and no action is taken. Refer to Chapter 4 of the *HP 8673 Compatibility Guide* for more information.

1802 1802, "Low Battery Voltage;(1802)"

The synthesizer battery voltage is low. This could cause loss of RAM data if signal generator power is turned off. Note: Calibration data will never be lost.

1803 1803, "RAM data lost at power on;(1803)"

All RAM data was lost. This includes all front panel settings, save/recall registers, level corrections, and other user settable values. This error message can occur when the battery voltage is low, or options change in the synthesizer. Note: Calibration data will never be lost.

1804 1804, "Self test failure, run the self test;(1804)"

The power-on self test detected an error or warning. See the explanation for error number 4000.

1805 1805, "Processor Board or IBUS test Failure;(1805)"

The power-on self test detected an error or warning for the microprocessor board circuits or power supply monitors. See the explanation for error number 4000.

1806 1806, "ROM checksum test failure;(1806)"

The synthesizer ROM check sum does not match the data in ROM. See the explanation for error number 4000.

Messages

2003 –222, "Data out of range;CW FREQ(2003)"

Select a CW frequency that is within range of the installed options. If other modules or options are installed that extend the CW frequency range of the synthesizer, this frequency range will be extended also.

2006 –222, "Data out of range;POWER LEVEL(2006)"

Select a power level within the following ranges:
No attenuator options, –15 dBm to +30 dBm. Option 1E1, –100 dBm to +30 dBm.

2012 –224, "Illegal parameter value;ALC SOURCE(2012)"

The requested ALC source is not available in the synthesizer. Use *OPT? to check which options are installed.

2015 –222, "Data out of range;SPECIAL(2015)"

Select a special function number that is available in the synthesizer.

2018 –222, "Data out of range;FREQ MULTIPLIER INCR(2018)"

2024 –222, "Data out of range;CW FREQ INCR(2024)"

Select a CW frequency increment from 1 kHz to 19.99 GHz. If other modules or options are installed that extend the CW frequency range of the synthesizer, this frequency range will be extended also. If Option 1E8 is installed the limits will also change to allow for 1 Hertz resolution.

2030 –222, "Data out of range;DIRECT HW CONTROL(2030)"

Select synthesizer direct hardware control values within range. See the service manual for more details on this feature.

2033 –222, "Data out of range;POWER LEVEL INCR(2033)"

Select a power level within the following ranges:
No attenuator options, 0.01 dBm to +45 dBm. Option 1E1, 0.01 dBm to +130 dBm.

2036 –222, "Data out of range;EXT METER LEVEL(2036)"

Select an external power meter reading within the following ranges:
No attenuator options, –15 dBm to +30 dBm. Option 1E1, –100 dBm to +30 dBm.

2042 –222, "Data out of range;DIAG:IBUS:DIR(2042)"

Correct the HP-IB command DIAG:IBUS:DIR or DIAG:IBUS:DIR? so that its parameters are within their appropriate ranges. See the service manual for more details on this HP-IB only feature.

2045 –224, "Illegal parameter value; *EMC (2045)"

This command requires a 1 or 0 as an argument.

2048 –222, "Data out of range;SYST:KEY(2048)"

Select a key code available on the synthesizer's front panel.

2051 –161, "Invalid block data;SYST:SET bad size(2051)"

The "learn string" sent to the synthesizer is corrupt (incorrect number of bytes). Check that the HP-IB controller is sending the string correctly. In addition, insure that the controller loaded the learn string correctly in the first place. Note: The *LRN? query always returns the same length string regardless of the state of the synthesizer; but, the *LRN? response can change if the firmware version changes.

2054 –222, "Data out of range;CAL:ALC:CURV(2054)"

Correct the HP-IB command CAL:ALC:CURV so that its parameters are within the following ranges:

1st parameter: 0.0 to 4.0

2nd parameter: –2.0 to 2.0

3rd-6th parameter: –1.0 to 1.0

7th parameter: 0.0 to 25.0

2057 –222, "Data out of range;HPIB ADDRESS(2057)"

Select an HP-IB address for the synthesizer from 0 to 30.

2060 –222, "Data out of range;SAVE(2060)"

Select a save state register number from 0 to 9.

2066 –222, "Data out of range;RECALL(2066)"

Select a recall state register number from 0 to 9.

2075 –222, "Data out of range;LO FREQ(2075)"

Select an LO frequency from 300 MHz to 359.5 MHz.

2078 –222, "Data out of range;OFFSET FREQ(2078)"

Select an offset frequency from 5 MHz to 40 MHz.

Messages

- 2081 –222, "Data out of range;DIAG:FREQ:CYCL(2081)"
Correct the HP-IB command DIAG:FREQ:CYCL so that its parameters are within range. See the service manual for more details on this feature.
- 2087 –222, "Data out of range;YIG OSC CAL FREQ(2087)"
Correct the HP-IB command CAL:YIG:FREQ:STARt so that its parameter is 2 GHz or 10 GHz.
- 2090 –222, "Data out of range;CAL:YIG(2090)"
Correct the HP-IB command CAL:YIG[:DATA] so that all of its parameters are from 0 to 65535.
- 2099 –222, "Data out of range;FREQ MULTIPLIER(2099)"
Select a frequency multiplier from 1 to 100.
- 2102 –222, "Data out of range;EXT METER INCR(2102)"
Select an external power meter reading increment within the following ranges:
No attenuator options, 0.01 dBm to +45 dBm. Option 1E1, 0.01 dBm to +130 dBm.
- 2105 –222, "Data out of range;CAL:ALC:CURV:FREQ(2105)"
Correct the HP-IB command CAL:ALC:CURVe:FREQuency:STARt so that its parameter is from 10 MHz to 40 GHz. See the service manual for more details on this feature.
- 2111 –224, "Illegal parameter value; *PSC (2111)"
This command requires a 1 or 0 as an argument.
- 2114 –224, "Illegal parameter value;ATTEN LOCK(2114)"
The HP-IB command "POWEr:ATTenuation:AUTO OFF" can only be used if Option 1E1 is installed.
- 2165 –224, "Illegal parameter value;REMOTE LANGUAGE(2165)"
Select an HP-IB remote language which is available in the synthesizer. "SCPI" is the default but others are available as options.
- 2177 –222, "Data out of range;CAL:FLAT(2177)"
Loss data for factory frequency level correction was out of range.

- 2189 –224, "Illegal parameter value; DISPLAY STATE(2189)"
The display state could not be set to the state requested.
- 2192 –224, "Illegal parameter value; LEV CORR STATE (2192)"
This command requires a boolean argument.
- 2198 –224, "Illegal parameter value; EXT REF(2198)"
The reference oscillator could not be set to INTERNAL because an internal oscillator does not exist or the reference oscillator could not be set to EXTERNAL because an external oscillator does not exist.
- 2210 –222, "Data out of range; ASSEMBLY REVISION (2210)"
The value must remain between 0 and +254.
- 2216 –222, "Data out of range; NODE MEASURE(2216)"
Select a meter node number within range. See the service manual for more details on this feature.
- 2219 –222, "Data out of range; OPTION WRITE(2219)"
Select an option bit-field number within range. See the service manual for more details on this feature.
- 2237 –222, "Data out of range; OFFSET FREQ INCR(2237)"
Select an offset frequency increment from 1 kHz to 35 MHz. If the Option 1E8 is installed the lower limit will change to 1Hz to allow for 1 Hertz resolution.
- 2240 –222, "Data out of range; LO FREQ INCR(2240)"
Select an LO frequency increment from 1 kHz to 359.5 MHz.
- 2243 –222, "Data out of range; DIRECT HW CONTROL INC(2243)"
Select synthesizer direct hardware control increment values within range. See the service manual for more details on this feature.
- 2249 –222, "Data out of range; DIAG:ABUS?(2249)"
Correct the HP-IB query DIAG:ABUS? so that its parameter is within their appropriate range. See the service manual for more details on this HP-IB only feature.
- 2276 –222, "Data out of range; CORR:FLAT(2276)"

Messages

Correct the HP-IB command CORRection:FLATness[:DATA] so that all of its frequency parameters are from 1 GHz to 20 GHz and all of its loss parameters are from -40 dB to +40 dB. If other modules or options are installed that extend the frequency range of the synthesizer, this frequency range will be extended also.

2277 2277,"CORR:FLAT cannot query empty table;(2277)"

The selected level correction table data cannot be queried because it is invalid or it does not exist. Check that MEMOrY:TABLE:SElect is set to a level correction table that has data.

2291 -224,"Illegal parameter value;SERIAL NUM(2291)"

Correct the HP-IB command SYSTem:SNUMber so that its string parameter is 10 characters or less.

2292 -151,"Invalid string data;SERIAL NUM bad char(2292)"

A serial number can only contain characters from ASCII 32 (space) through ASCII 126 (~). However, ASCII 44 (,) and ASCII 59 (;) cannot be used.

2294 -222,"Data out of range;POW METER ADDRESS(2294)"

Select a power meter address for automatic level correction from 0 to 30. Secondary addresses may be allowed in future firmware revisions.

2300 -222,"Data out of range;CAL:FLAT:FREQ:START(2300)"

Correct the HP-IB command CAL:FLATness:FREQUency:STARt so that its parameter is from 10 MHz to 40 GHz. See the service manual for more details on this feature.

2303 -222,"Data out of range;CAL:FLAT:ATT(2303)"

Correct the HP-IB command CAL:FLATness:ATTenuation so that its parameter is from 0 dB to 120 dB with a resolution of 10 dB. See the service manual for more details on this feature.

2444 -222,"Data out of range;LEVEL CORR START FREQ(2444)"

Select an automatic level correction start frequency from 1GHz to 20GHz. If other modules or options are installed that extend the CW frequency range of the synthesizer, this frequency range will be extended also.

2447 -222,"Data out of range;LEVEL CORR STOP FREQ(2447)"

Select an automatic level correction start frequency from 1GHz to 20GHz. If other modules or options are installed that extend the CW frequency range of the synthesizer, this frequency range will be extended also.

2457 2457,"RF on before running level correct;(2457)"

The RF must be turned on before running an automatic level correction. Turn RF on and try running the automatic level correction again.

2462 -222,"Data out of range;LEVEL CORR START INC(2462)"

Select an automatic level correction start frequency increment from 1 kHz to 19.99 GHz. If other modules or options are installed that extend the CW frequency range of the synthesizer, this frequency range will be extended also. If Option 1E8 is installed the limits will also change to allow for 1 Hertz resolution.

2465 -222,"Data out of range;LEVEL CORR STOP INC(2465)"

Select an automatic level correction stop frequency increment from 1 kHz to 19.99 GHz. If other modules or options are installed that extend the CW frequency range of the synthesizer, this frequency range will be extended also. If the Option 1E8 is installed the limits will also change to allow for 1 Hertz resolution.

2471 -222,"Data out of range;HP-IB ADDRESS INCR(2471)"

Select an HP-IB address increment from 1 to 29.

2474 -222,"Data out of range;YIG OSC CAL FREQ INC(2474)"

Correct the HP-IB command CAL:YIG:FREQuency:STARt:STEP so that its parameter is from 1 GHz to 10 GHz.

2522 -222,"Data out of range;POW METER ADDRESS INC(2522)"

Select a power meter address increment from 1 to 29.

2525 -222,"Data out of range;NODE MEASURE INC(2525)"

Select a meter node increment within range.

2531 -222,"Data out of range;LEVEL CORR POINTS(2531)"

Select automatic level correction number of points from 2 to 401.

2534 -222,"Data out of range;LEVEL CORR POINTS INC(2534)"

Messages

- Select automatic level correction number of points increment from 1 to 401.
- 2537 –222, "Data out of range;LEVEL CORRECT SAVE(2537)"
Select an automatic level correction register from 1 to 4.
- 2540 –222, "Data out of range;LEVEL CORR SELECT(2540)"
Select an automatic level correction register from 1 to 4.
- 2570 –224, "Illegal parameter value;POWERMETER TYPE(2570)"
The selected power type is not supported by the synthesizer.
- 2588 –224, "Illegal parameter value;MEM:TABL:SEL(2588)"
Select an automatic level correction register from 1 to 4.
- 2591 –222, "Data out of range;MEM:TABL:FREQ(2591)"
Correct the HP-IB command MEMory:TABLE:FREQuency so that all of its parameters are from 1 GHz to 20 GHz. If other modules or options are installed that extend the frequency range of the synthesizer, this frequency range will be extended also.
- 2592 2592, "MEM:TABL:FREQ cannot query empty table;(2592)"
The selected level correction table data cannot be queried because it is invalid or it does not exist. Check that MEMory:TABLE:SElect is set to a level correction table that has data.
- 2597 –222, "Data out of range;MEM:TABL:LOSS(2597)"
Correct the HP-IB command MEMory:TABLE:LOSS[:MAGnitude] so that all of its parameters are from –40 dB to +40 dB.
- 2598 2598, "MEM:TABL:LOSS cannot query empty table;(2598)"
The selected level correction table data cannot be queried because it is invalid or it does not exist. Check that MEMory:TABLE:SElect is set to a level correction table that has data.
- 2702 –222, "Data out of range;ADD OPTION(2702)"
Select an option bit number within range. See the service manual for more details on this feature.
- 2705 –222, "Data out of range;DELETE OPTION(2705)"

Select an option bit number within range. See the service manual for more details on this feature.

4000 –330,"Self test failed;(4000)"

Run the instrument self test a couple times, checking the error queue each time the self test is run. If the error message persists, use the ERASE MEMORY feature, press the preset key and cycle the power; try the self test again. If the error message persists, an instrument failure may have occurred and servicing may be required. If the synthesizer is functioning to your satisfaction, you may wish to ignore the error message.

4001 –330,"Self test failed;(4001)"

See the explanation for error number 4000.

4002 –330,"Self test failed;(4002)"

See the explanation for error number 4000.

4003 –330,"Self test failed;(4003)"

See the explanation for error number 4000.

4004 –330,"Self test failed;(4004)"

See the explanation for error number 4000.

4005 –330,"Self test failed;(4005)"

See the explanation for error number 4000.

4006 –330,"Self test failed;(4006)"

See the explanation for error number 4000.

4007 –330,"Self test failed;(4007)"

See the explanation for error number 4000.

4008 –330,"Self test failed;(4008)"

See the explanation for error number 4000.

4009 –330,"Self test failed;(4009)"

See the explanation for error number 4000.

4010 –330,"Self test failed;(4010)"

See the explanation for error number 4000.

Messages

- 4011 –330,"Self test failed;(4011)"
See the explanation for error number 4000.
- 4012 –330,"Self test failed;(4012)"
See the explanation for error number 4000.
- 4013 –330,"Self test failed;(4013)"
See the explanation for error number 4000.
- 4014 –330,"Self test failed;(4014)"
See the explanation for error number 4000.
- 4015 –330,"Self test failed;(4015)"
See the explanation for error number 4000.
- 4016 –330,"Self test failed;(4016)"
See the explanation for error number 4000.
- 4017 –330,"Self test failed;(4017)"
See the explanation for error number 4000.
- 4018 –330,"Self test failed;(4018)"
See the explanation for error number 4000.
- 4019 –330,"Self test failed;(4019)"
See the explanation for error number 4000.
- 4020 –330,"Self test failed;(4020)"
See the explanation for error number 4000.
- 4021 –330,"Self test failed;(4021)"
See the explanation for error number 4000.
- 4022 –330,"Self test failed;(4022)"
See the explanation for error number 4000.
- 4023 –330,"Self test failed;(4023)"
See the explanation for error number 4000.
- 4024 –330,"Self test failed;(4024)"

- See the explanation for error number 4000.
- 4025 –330,"Self test failed;(4025)"
See the explanation for error number 4000.
- 4026 –330,"Self test failed;(4026)"
See the explanation for error number 4000.
- 4027 –330,"Self test failed;(4027)"
See the explanation for error number 4000.
- 4028 –330,"Self test failed;(4028)"
See the explanation for error number 4000.
- 4029 –330,"Self test failed;(4029)"
See the explanation for error number 4000.
- 4030 –330,"Self test failed;(4030)"
See the explanation for error number 4000.
- 4031 –330,"Self test failed;(4031)"
See the explanation for error number 4000.
- 4032 –330,"Self test failed;(4032)"
See the explanation for error number 4000.
- 4033 –330,"Self test failed;(4033)"
See the explanation for error number 4000.
- 4034 –330,"Self test failed;(4034)"
See the explanation for error number 4000.
- 4035 –330,"Self test failed;(4035)"
See the explanation for error number 4000.
- 4036 –330,"Self test failed;(4036)"
See the explanation for error number 4000.
- 4037 –330,"Self test failed;(4037)"
See the explanation for error number 4000.

Error Messages

4038 –330,"Self test failed;(4038)"
See the explanation for error number 4000.

4039 –330,"Self test failed;(4039)"
See the explanation for error number 4000.

4040 –330,"Self test failed;(4040)"
See the explanation for error number 4000.

4041 –330,"Self test failed;(4041)"
See the explanation for error number 4000.

4042 –330,"Self test failed;(4042)"
See the explanation for error number 4000.

4043 –330,"Self test failed;(4043)"
See the explanation for error number 4000.

4044 –330,"Self test failed;(4044)"
See the explanation for error number 4000.

4045 –330,"Self test failed;(4045)"
See the explanation for error number 4000.

9000 –330,"Self test failed;(9000)"
See the explanation for error number 4000.

9500-
9999 **Many different error messages can occur here.**

Errors with a number from 9500 to 9999 are MMS MSIB errors. These errors occur when the synthesizer has some problem with communication over the MSIB bus. See the explanation for error number 4000.

Legal and Regulatory
Information

Legal and Regulatory Information

This chapter contains information pertaining to safety and the warranty. The Declaration of Conformity is located at the end of this chapter.

Safety Symbols



Instruction documentation symbol: The product is marked with this symbol when it is necessary for the user to refer to the instruction in the documentation.



Indicates hazardous voltages.



Indicates earth (ground) terminal.

WARNING

The **WARNING** sign denotes a hazard. It calls attention to a procedure which, if not correctly performed or adhered to, could result in personal injury or loss of life. Do not proceed beyond a **WARNING** note until the indicated conditions are fully understood and met.

CAUTION

The **CAUTION** sign denotes a hazard. It calls attention to a procedure that, if not correctly performed or adhered to, could result in damage to or destruction of part of the product. Do not proceed beyond a **CAUTION** note until the indicated conditions are fully understood and met.

WARNING

No operator serviceable parts inside. Refer servicing to qualified personnel. To prevent electrical shock do not remove covers.

Miscellaneous Symbols

- CE The CE symbol is a registered trademark of the European Community (if accompanied by a year, it is when the design was proven).
- ISM 1-A This is a symbol of an Industrial Scientific and Medical Group 1 Class A product.
- CSA The CSA symbol is a registered trademark of the Canadian Standards Association.

Safety Considerations

This product and related documentation must be reviewed for familiarization with safety markings and instructions before operation.

This product is a Safety Class I system (provided with a protective earth terminal).

Before Applying Power

Verify that the product is set to match the available line voltage and the correct fuses are installed.

CAUTION

This product is designed for use in Installation Category II and Pollution Degree 2 per IEC 1010 and 664 respectively.

CAUTION

VENTILATION REQUIREMENTS: When installing the product in a cabinet, the convection into and out of the product must not be restricted. The ambient temperature (outside the cabinet) must be less than the maximum operating temperature of the product by 4 °C for every 100 watts dissipated in the cabinet. If the total power dissipated in the cabinet is greater than 800 watts, then forced convection must be used.

Safety Earth Ground

An uninterruptable safety earth ground must be provided from the main power source to the product input wiring terminals through the power cable or supplied power cable set.

Safety Considerations

WARNING

This is a Safety Class I product provided with a protective earthing ground incorporated in the power cord. The mains plug shall only be inserted in a socket outlet provided with a protective earth contact. Any interruption of the protective conductor inside or outside of the product is likely to make the product dangerous. Intentional interruption is prohibited.

Whenever it is likely that the protection has been impaired, the system must be made inoperative and be secured against any unintended operation.

Servicing instructions are for use by service-trained personnel only. To avoid dangerous electric shock, do not perform any servicing unless qualified to do so.

Adjustments described in the manual are performed with power supplied to the system's instruments while protective covers are removed. Energy available at many points may, if contacted, result in personal injury.

Capacitors inside the system's instruments might still be charged even if the system has been disconnected from its source of supply.

For continued protection against fire hazard, replace the line fuses only with 250 V fuses of the same current rating and type (for example, normal blow, time delay, etc.). The use of other fuses or materials is prohibited.

Cleaning the Product

Clean the synthesizer cabinet using a damp cloth only.

Certification

Hewlett-Packard Company certifies that this product met its published specifications at the time of shipment from the factory. Hewlett-Packard further certifies that its calibration measurements are traceable to the United States National Institute of Standards and Technology, (NIST), to the extent allowed by the Institute's calibration facility, and to the calibration facilities of other International Standards Organization members.

Warranty

This Hewlett-Packard instrument product is warranted against defects in material and workmanship for a period of one year from date of shipment. During the warranty period, Hewlett-Packard Company will, at its option, either repair or replace products which prove to be defective.

For warranty service or repair, this product must be returned to a service facility designated by HP. Buyer shall prepay shipping charges to HP and HP shall pay shipping charges to return the product to Buyer. However, Buyer shall pay all shipping charges, duties, and taxes for products returned to HP from another country.

HP warrants that its software and firmware designated by HP for use with an instrument will execute its programming instructions when properly installed on that instrument. HP does not warrant that the operation of the instrument, or software, or firmware will be uninterrupted or error free.

Limitation of Warranty

The foregoing warranty shall not apply to defects resulting from improper or inadequate maintenance by Buyer, Buyer-supplied software or interfacing, unauthorized modification or misuse, operation outside of the environmental specifications for the product, or improper site preparation or maintenance.

NO OTHER WARRANTY IS EXPRESSED OR IMPLIED. HP SPECIFICALLY DISCLAIMS THE IMPLIED WARRANTIES OF MERCHANTABILITY AND FITNESS FOR A PARTICULAR PURPOSE.

Exclusive Remedies

THE REMEDIES PROVIDED HEREIN ARE BUYER'S SOLE AND EXCLUSIVE REMEDIES. HP SHALL NOT BE LIABLE FOR ANY DIRECT, INDIRECT, SPECIAL, INCIDENTAL, OR CONSEQUENTIAL DAMAGES, WHETHER BASED ON CONTRACT, TORT, OR ANY OTHER LEGAL THEORY.

Assistance

Product maintenance agreements and other customer assistance agreements are available for Hewlett-Packard products.

For any assistance, contact your nearest Hewlett-Packard Sales and Service Office shown in Table 9-1.

Assistance

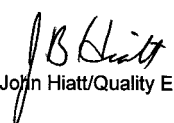
DECLARATION OF CONFORMITY	
according to ISO/IEC Guide 22 and EN 45014	
Manufacturer's Name:	Hewlett-Packard Co.
Manufacturer's Address:	Microwave Instruments Division 1212 Valley House Drive Rohnert Park, CA 94928 USA
declares that the products	
Product Name:	Synthesized Generators
Model Number:	HP 83711A, HP 83711B, HP 83712A, HP 83712B, HP 83731B, HP 83732B
Product Options:	This declaration covers all options of the above product.
conforms to the following Product specifications:	
Safety: IEC 1010-1:1990 + Am 1:1992/EN 61010-1:1993 CAN/CSA-C22.2 No. 1010.1-1992	
EMC: CISPR 11:1990/EN 55011:1991 Group 1, Class A IEC 801-2:1984/EN 50082-1:1992 4 kV CD, 8 kV AD IEC 801-3:1984/EN 50082-1:1992 3 V/m, 27-500 MHz IEC 801-4:1988/EN 50082-1:1992 0.5 kV Sig. Lines, 1 kV Power Lines	
IEC 555-2:1982 + A1:1985 / EN 60555-2:1987 IEC 555-3:1982 + A1:1990 / EN 60555-3:1987 + A1:1991	
Supplementary Information:	
These products herewith comply with the requirements of the Low Voltage Directive 73/23/EEC and the EMC Directive 89/336/EEC and carry the CE-marking accordingly.	
Santa Rosa, California, USA	17 June 1997
	 John Hiatt/Quality Engineering Manager
European Contact: Your local Hewlett-Packard Sales and Service Office or Hewlett-Packard GmbH, Department ZQ/Standards Europe, Herrenberger Strasse 130, D-71034 Böblingen, Germany (FAX +49-7031-14-3143), 49-7031-14-3143)	

Notice for Germany: Noise Declaration
LpA < 70 dB
am Arbeitsplatz (operator position)
normaler Betrieb (normal position)
nach DIN 45635 T. 19 (per ISO 7779)

Legal and Regulatory Information

Index

- 0 0.5 V/GHz OUT connector, 5-7

- 1 10 MHz IN connector, 5-7
10 MHz OUT connector, 5-7
1 Hz frequency resolution - option 1E8, 4-20

- 3 3.5 mm RF output connector - option 1E9, 4-20

- 4 488.1 compatibility codes, 5-9

- A active parameter, 6-40
add output step attenuator - option 1E1, 4-20
address, 6-11
 - setting the HP-IB, 2-12advantages
 - attenuator hold function, 7-4ALC IN connector, v, 5-7
ALC unleveled condition, 6-27
annunciators, v, 5-3, 5-11
 - fluorescent display, 5-11
 - LED, 5-11ANSI Standard MC1.1, 5-10
application
 - attenuator hold function, 7-4
 - erase memory function, 7-8arrow keys
 - modifying data with, 2-6ATTEN HOLD ON/OFF, 7-3
attenuator hold function, 7-3
automatic level control keys, v

B BACK SPACE, v, 6-12

 key, v, 6-9

 key, v, 6-5

 key, v, 6-3

 key, v, 6-7

book introduction, vi

C carrier keys, v

CLEAR DISPLAY, 7-6

coaxial connectors, 5-6-8

component-level information packet - option OBV, 4-23

component-level information packet/service documentation - option OBX, 4-23

connector care, 5-7

connectors, 5-6

coaxial, 5-6-8

damage levels, 5-6-8

front panel, 5-6

HP-IB, 5-8-10

impedances, 5-6-8

rear panel, 5-6

cursor, v

cursor, double, 2-3, 6-3, 6-5

CW signal

generating, 3-3

D damage

electrical, 1-8

mechanical, 1-3, 1-8

data

entering with numeric keypad, 2-3

modifying with arrow keys, 2-6

modifying with knob, 2-4

data entry keys, v

data entry problems, 2-13-14

default state

display, 6-13

delete operating documentation - option OB0, 4-22

DIODE (ALC) annunciator, 5-3

diode detector leveling

advantages, 6-18

applications, 6-17

disadvantages, 6-18

using, 3-7

diode detector square law region, 6-17, 6-18

disadvantages

attenuator hold function, 7-5

display, 5-11

- default state, 6-13
- documentation options, 4-22
- double cursor, 6-3, 6-5

- E**
- earth ground
 - for safety, 1-6, 9-5
 - electrical options, 4-20
 - ENTER, 6-13
 - ENTRY OFF function, 2-13, 6-15
 - ERASE MEMORY, 7-8
 - erase memory function, 7-8
 - error message
 - action required, 8-3
 - detailed description, 8-3
 - hardware failures, 8-4
 - manual error number, 8-3
 - SCPI error message, 8-3
 - SCPI error number, 8-3
 - error message format, 8-3
 - error messages
 - user-oriented, v
 - error messages list, 8-5-40
 - error queue
 - reading, 2-10
 - errors
 - permanent, 8-2
 - EXT DIODE, 6-16
 - EXT METER, 6-20
 - extra operating documentation - option OB1, 4-22
 - EXT REF annunciator, 5-3
- F**
- factory calibration data, 7-8
 - failures
 - self test, 1-11
 - fan
 - checking, 1-10
 - FREQ, 6-25
 - fuse
 - checking, 1-9

- H** HP-IB address
 - setting, 2-12
 - HP-IB connector, 5-8-10
 - HP-IB extender instruments, 5-9
 - HP-IB interface capabilities, 5-9
 - HP-IB restrictions, 5-8

- I** IEEE Standard 488 (1978), 5-10
 - increment value, 2-6, 6-57
 - installing the synthesizer, 1-3
 - instrument state recall, 6-47
 - instrument state save, 6-49
 - INT (ALC) annunciator, 5-3
 - interface capabilities
 - HP-IB, 5-9
 - internal leveling
 - advantages, 6-28
 - disadvantages, 6-28
 - in this book, vi
 - INT LEVEL, 6-27
 - introduction
 - book, vi

- K** keypad
 - numeric, 6-40
 - knob, v, 5-13
 - modifying data with, 2-4
 - knob resolution
 - decreasing, 2-4
 - increasing, 2-4

- L** legal and regulatory information, 9-2
 - level correct data
 - using previously stored, 3-20
 - level correction register, 6-45, 6-50
 - level correct routine, 6-31
 - using, 3-14
 - leveling
 - using diode detector, 3-7
 - using power meter, 3-11
 - line voltage selector, 1-5
 - LLO, 6-30
 - LOCAL, 6-30
 - LOCAL key, 2-13
 - local lockout, 6-30
 - LSN annunciator, 5-4
 - LVL CR, 6-31

LVL CR annunciator, 5-4
LVL CR ON/OFF, 6-35

M mating connectors

RF OUPUT, v
mechanical damage, 1-3
mechanical options, 4-21
millimeter signals
 generating, 3-4
MSG, v, 6-37
MSG annunciator, 1-11, 3-23, 5-4
MTR (ALC) annunciator, 5-3
MULT annunciator, 5-3
multiplier, 6-38
multiplier value, 6-38
multiplier values for HP source modules, 3-4

N number of points, 6-31

numeric keypad, 6-40
 entering data with, 2-3

O option 1CM - rack mount kit, 4-21

option 1CP - rack mount and handle kit, 4-21
option 1CR - rack slide kit, 4-21
option 1E1 - add output step attenuator, 4-20
option 1E5 - add high stability timebase, 4-20
option 1E8 - 1 Hz frequency resolution, 4-20
option 1E9 - 3.5 mm RF output connector, 4-20
option OB0 - delete operating documentation, 4-22
option OB1 - extra operating documentation, 4-22
option OBV - component-level information packet, 4-23
option OBW - service documentation, 4-23
option OBX - component-level information packet/service documentation, 4-23
options, 4-17
 documentation, 4-22
 electrical, 4-20
 mechanical, 4-21
 warranty, 4-21
option W30 - two years return-to-HP service, 4-22
option W32 - three year return-to-HP calibration service, 4-22
option W34 - three year Mil-std calibration service, 4-22

P parameter
 active, 6-40
 unitless, 6-13
permanent errors, 8-2
points
 number of, 6-31
power cable configurations, 5-16
power cables, 5-16
POWER LEVEL, 6-41
power meter address function, 7-10
power meter leveling
 advantages, 6-23
 applications, 6-22
 disadvantages, 6-23
 equipment limitations, 6-22
 using, 3-11
power meter select function, 7-12
POWER switch, v, 5-15
power-up problems, 1-8-11
PRESET, 6-43
problems
 data entry, 2-13-14
 power-up, 1-8-11
 programming, 2-15
 RF output, 3-23
programming problems, 2-15
PWR MTR ADDR5, 7-10
PWR MTR SELECT, 7-12

R rack mount and handle kit - option 1CP, 4-21
rack mount kit - option 1CM, 4-21
rack slide kit - option 1CR, 4-21
RCL CR, 6-45
reading the error queue, 2-10
RECALL, v, 6-46
recalling synthesizer states, 2-8
remote language, 7-14
restrictions
 HP-IB, 5-8
RF ON/OFF, 6-48
RF OUTPUT connector, v, 5-7
RF output problems, 3-23
RMT annunciator, 2-13, 5-4

S sales and service office table, 9-10
SAVE, v, 6-49
SAVE CR, 6-50
saving synthesizer states, 2-8
self test
 running, 1-7
SELF TEST, 7-15
self test failures, 1-11
self test function, 7-15
serial number, 7-18
service documentation - option OBW, 4-23
service-related special functions, 7-17
SHIFT, v, 6-52
SHOW INFO, 7-18
show information function, 7-18
software version number, 7-18
source modules
 multiplier values for, 3-4
SPCL, v, 6-53
SPCL annunciator, 5-3
SPCL OFF, 6-54
SPCL ON, 6-56
special functions, v, 6-53, 7-2
 service-related, 7-17
specifications, 4-3, 4-17
square law region
 diode detector, 6-17, 6-18
SRQ annunciator, 5-4
standby, 5-15
start frequency, 6-31
STEP SIZE, 6-57
STEP SIZE, v
STEP SIZE key, 2-6
stop frequency, 6-31
supplemental characteristics, 4-3, 4-9
synthesizer
 installing, 1-3
synthesizer at a glance, iv, v
synthesizer states
 saving and recalling, 2-8

- T** terminator keys, v, 2-3
three year Mil-std calibration service - option W34, 4-22
three year return-to-HP calibration service - option W32, 4-22
TLK annunciator, 5-4
to generate a CW signal, 3-3
to generate millimeter signals, 3-4
to use external diode detector leveling, 3-7
to use external power meter leveling, 3-11
to use previously stored level correct data, 3-20
to use the level correct routine, 3-14
turn-on sequence, 1-6
two years return-to-HP service - option W30, 4-22
- U** unitless parameters, 6-13
units terminator keys, 2-3
unleveled condition
 ALC, 6-27
UNLOCK annunciator, 5-4
UNLVL annunciator, 5-4
- V** verification procedure, 1-7
- W** warranty options, 4-21
